

TOSHIBA

Leading Innovation >>>



AIR TO WATER HEAT PUMP Installation Manual



Hydro Unit

Model name:

HWS-P805XWHM3-E

HWS-P805XWHT6-E

HWS-P805XWHT9-E

HWS-P1105XWHM3-E

HWS-P1105XWHT6-E

HWS-P1105XWHT9-E

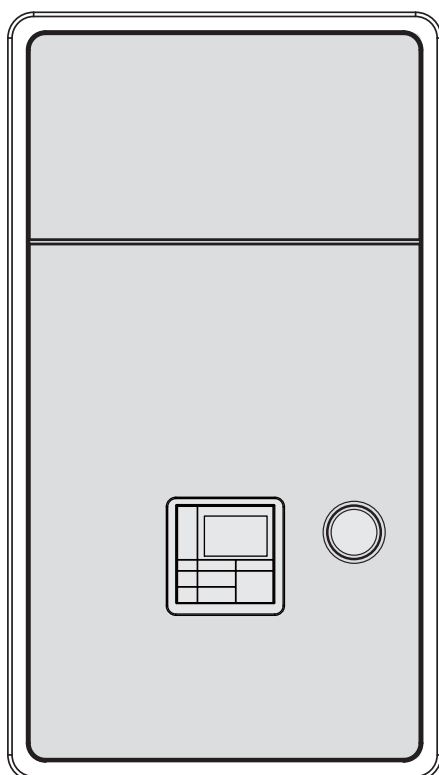

Please read this Installation Manual carefully before installing the Air to Water Heat Pump.

- This Manual describes the installation method of the hydro unit.
- For installation of the outdoor unit, follow the Installation Manual attached to the outdoor unit.

REFRIGERANT

This Air to Water Heat Pump uses an HFC refrigerant (R410A) in order to prevent destruction of the ozone layer.

Contents

1	General information	2
2	Accessory parts	3
3	Preparations for installation	4
4	Precautions for safety	5
5	Example of Hydro Unit installation	8
6	Main components of Hydro Unit	10
7	Hydro Unit installation	12
8	Group Control	30
9	Start up and configuration	31
10	Maintenance	54
11	Troubleshooting	55

1 General information

■ System combination

Hydro Unit	Outdoor Unit		Backup heater
	HWS-P805HR-E	HWS-P1105HR-E	
HWS-P805XWHM3-E	○	–	~, 3 kW
HWS-P805XWHT6-E	○	–	3N~, 6 kW
HWS-P805XWHT9-E	○	–	3N~, 9 kW
HWS-P1105XWHM3-E	–	○	~, 3 kW
HWS-P1105XWHT6-E	–	○	3N~, 6 kW
HWS-P1105XWHT9-E	–	○	3N~, 9 kW
220-230 V model			

■ General specifications

Outdoor Unit

Outdoor unit		HWS-P805HR-E	HWS-P1105HR-E
Power supply		220-230 V ~ 50 Hz	
Type		INVERTER	
Function		Heating & Cooling	
Heating	Capacity (kW)	8.0	11.2
	Input (kW)	1.68	2.30
	COP (W/W)	4.76	4.88
Cooling	Capacity (kW)	6.0	10.0
	Input (kW)	1.64	3.33
	EER (W/W)	3.66	3.00
Refrigerant		R410A	
Dimension	HxWxD (mm)	1,340x900x320	

Hydro Unit

8 kW model

Hydro Unit		HWS-P805XWHM3-E	HWS-P805XWHT6-E	HWS-P805XWHT9-E
Back up heater capacity (kW)		3.0	6.0	9.0
Power supply	for back up heater	220-230 V ~ 50 Hz	380-400 V 3N~ 50 Hz	380-400 V 3N~ 50 Hz
	for hot water cylinder heater (option)	220-230 V ~ 50 Hz		
Leaving water temperature	Heating (°C)	20-60		
	Cooling (°C)	7-25		

11 kW model

Hydro Unit		HWS-P1105XWHM3-E	HWS-P1105XWHT6-E	HWS-P1105XWHT9-E
Back up heater capacity (kW)		3.0	6.0	9.0
Power supply	for back up heater	220-230 V ~ 50 Hz	380-400 V 3N~ 50 Hz	380-400 V 3N~ 50 Hz
	for hot water cylinder heater (option)	220-230 V ~ 50 Hz		
Leaving water temperature	Heating (°C)	20-60		
	Cooling (°C)	7-25		

Hot Water Cylinder (option)

Hot water cylinder (option)	HWS-1501CSHM3-E HWS-1501CSHM3-UK	HWS-2101CSHM3-E HWS-2101CSHM3-UK	HWS-3001CSHM3-E HWS-3001CSHM3-UK
Water volume (liter)	150	210	300
Power supply	220-230 V ~ 50 Hz		
Max water temperature (°C)	75		
Electric heater (kW)	2.7		
Height (mm)	1,090	1,474	2,040
Diameter (mm)	550		
Material	Stainless steel		

2 Accessory parts

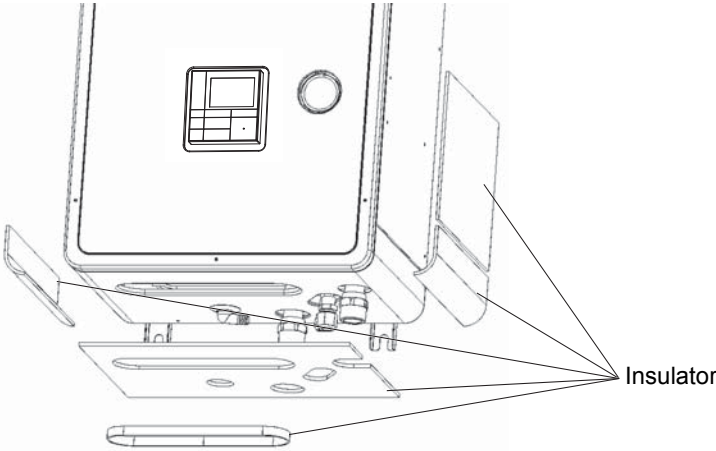
No.	Parts name	Quantity
1	Installation Manual (this document)	1
2	Owner's Manual	1
3	Insulator for cooling 	5

3 Preparations for installation

■ Parts required to connect this product (Common items)

Category	Part	Specification	Quantity
Water piping	Strainer (water filter)	1 1/4" 30 to 40 meshes	1
	Drain cock	(for water charge)	1
	Isolating ball valves	1 1/4" for service 1 1/4"	2
Electrical system	Earth leakage breaker for main power supply	30 mA	1
	Earth leakage breaker for backup heater	30 mA	1
	(Option) Earth leakage breaker for hot water cylinder heater	30 mA	1

■ Options required for each function

Purpose	In the Hydro Unit		Purchased part		
	Part name	Model name	Part name	Prescribed specification	
Heating	–	–	Radiator(s), Fan coil(s), Under floor heating		
Heating & Cooling (all rooms)	–	–	Fan coil(s)		
Heating & Cooling (partly heating only)	–	–	Motorized 2-way valve (for cooling)	Refer to "Control parts specifications" on page 21.	
Hot water supply	Hot water cylinder	150 L	HWS-1501CSHM3-E	Motorized 3-way valve Earth leakage breaker	Refer to "Control parts specifications" on page 21.
			HWS-1501CSHM3-UK		
	210 L	HWS-2101CSHM3-E			
		HWS-2101CSHM3-UK			
	300 L	HWS-3001CSHM3-E			
		HWS-3001CSHM3-UK			
2-zone control	–	–	Motorized mixing valve	Refer to "Control parts specifications" on page 21.	
			Circulator pump	Other power supply	
			Buffer tank		
Interlocking with boiler	Output control board kit (1)	TCB-PCIN3E	Boiler	Other power supply. Signal 12 V input function is required for boiler.	

■ Optional parts

No.	Part name	Model name	Application	Remarks
1	External output board	TCB-PCIN3E	Boiler-linked output, Alarm output	Up to two boards (according to applications)
			Defrost signal output, compressor operation signal output	
2	External input board	TCB-PCMO3E	Cooling/heating thermostat input	Up to two boards (according to applications)
			Emergency stop signal input.	

Use specified products for the outdoor unit, Hydro Unit, and hot water cylinder.

Do not use commercially available products.

Use parts that conform to prescribed specifications for parts to be connected to the Hydro Unit.

If unspecified products or parts are used, a malfunction, failure or fire may be caused.

4 Precautions for safety

■ General safety precautions

Ensure that all Local, National and International regulations are satisfied.

- Read the “Precautions for safety” carefully before installation.
- The precautions described below include the important items regarding safety – Observe them without fail.
- After the installation work has been completed, perform a test run to check for any problems. Follow the Owner’s Manual to explain how to use and maintain the unit to the customer.
- Turn off the main power supply switch (or breaker) before unit maintenance.
- Ask the customer to keep the Installation Manual along with the Owner’s Manual.

■ Refrigerant precautions

- If a refrigerant leak is suspected contact the dealer who supplied the system, in the case of a recharge of refrigerant ask service personnel for details of the leak and confirmation of the repairs completed.
The refrigerant used in the system is harmless.
- Generally the refrigerant does not leak, however, if the refrigerant should leak into a room and a heater or stove burner in the room is lit, toxic gas may be generated.
- Do not install the system in a location subject to a risk of exposure to a combustible gas. If a combustible gas leaks and stays around the unit a fire may occur.
- Install the refrigerant pipe securely during installation and before operation.
If the compressor is operated with no pipe work connected and valves open the compressor will suck air which would result in over pressurization of the system which may result in bursting or injury.
Observe the same precautions for refrigerant recovery work (pump back procedure to outdoor unit) and do not disconnect pipe work until refrigerant is recovered and valves closed.

WARNING

Installation precautions

- Ask an authorized dealer or qualified installation professional to install/maintain the Air to Water Heat Pump System.
Inappropriate installation may result in water leaks, electric shock or fire.
- Electrical work must be performed by a qualified electrician in accordance with the installation manual.
An inappropriate power supply capacity or installation may result in fire.
- When completing any electrical works to the system ensure that all Local, National and International regulations are satisfied.
Inappropriate grounding may result in electric shock.
- Ensure all electrical cables, used for the ESTIA installation, comply with all Local and National regulations. Check all electrical terminations are secure and tight.
- Earth wire connections.
- Install an earth leakage breaker without fail.
Incomplete grounding can cause electric shock.
Do not earth wires to gas pipes, water pipes, lightning rods or telephone cable earth wires.

- This unit must be connected to the main power supply using a circuit breaker or switch with a contact separation of at least 3 mm.
 - Be sure to turn off all main power supply switches or the circuit breaker before starting any electrical work.
Ensure all power switches are off, failure to do so can cause electric shock.
Use an exclusive power circuit for the Air to Water Heat Pump system using the rated voltage.
 - Ensure correct connection of interconnecting wire between Outdoor Unit and Hydro Unit.
Incorrect connection of the interconnecting cable may result in the damage of electrical parts.
 - Ensure refrigeration system remains sealed to external gases and air.
Should air or other gases contaminate the refrigeration circuit, high system pressures could result in burst pipes and injuries.
 - Do not modify or bypass any of safety guards or switches in this system.
 - After unpacking the outdoor unit, examine the unit carefully for any possible damage.
 - Do not install in any place that might increase the vibration of the unit.
 - To avoid personal injury (with sharp edges), be careful when handling parts.
 - Perform installation work properly in accordance with the installation manual.
Inappropriate installation may result in water leaks, electric shock or fire.
 - Tighten all flare nuts with a torque wrench in the specified manner.
Excessive tightening of the flare nut may result in cracking of the pipe work or flare nut which may result in a refrigerant leakage.
 - Wear heavy duty gloves during installation work to avoid injury.
 - Install the outdoor unit securely in a location where the base can sustain the weight adequately.
 - In enclosed areas, if the refrigerant leaks during installation vacate and ventilate immediately.
 - After installation is complete ensure and confirm that refrigerant does not leak.
If refrigerant leaks into a room and flows near a fire source noxious gas may be generated.
 - Do not block any drain hoses. Hoses may come off and electric shocks may occur.
 - Do not hit the manometer, because it is made of glass. It is breakable.
-

■ Notes on system design

- The inlet water temperature to the Hydro Unit must be 60 °C or less.
Especially, be careful when there is an external heating source such as a boiler.
When hot water over 60 °C returns, it may result in a failure of the unit or water leakage.
- The flow rate of the circulating water must meet the following range.
11 kW 18 L/minute or more
8 kW 13 L/minute or more
If the flow rate becomes less than the minimum, the protective device is activated to stop the operation.
To ensure the minimum flow rate of the water system, install a bypass valve on one water circuit. Please note this circuit must contain a minimum of 20 liters. If total water amount is not enough, the unit may not function fully due to protective operation.
- Do not drive water by power other than the pump built in the Hydro Unit.
- The back up heaters, in the hydro unit, are designed to assist the heat pump during periods of low ambient conditions.
- Ensure the Hydro unit and the connecting water pipes are installed in a location that is not exposed to low ambient temperatures which could result in the water circuit freezing.
- The system operation is designed around a closed water circuit. Do not use an open circuit design.
- Please turn on the main power supply to up to 12 hours before the start of the operation, and don't turn off the power all the time during the period of use.

5 Example of Hydro Unit installation

■ Example of installation for cooling and heating

When both cooling and heating modes are required a 2-way valve must be installed to isolate the radiator or under-floor heating circuit.

▼ Fig. 5-01

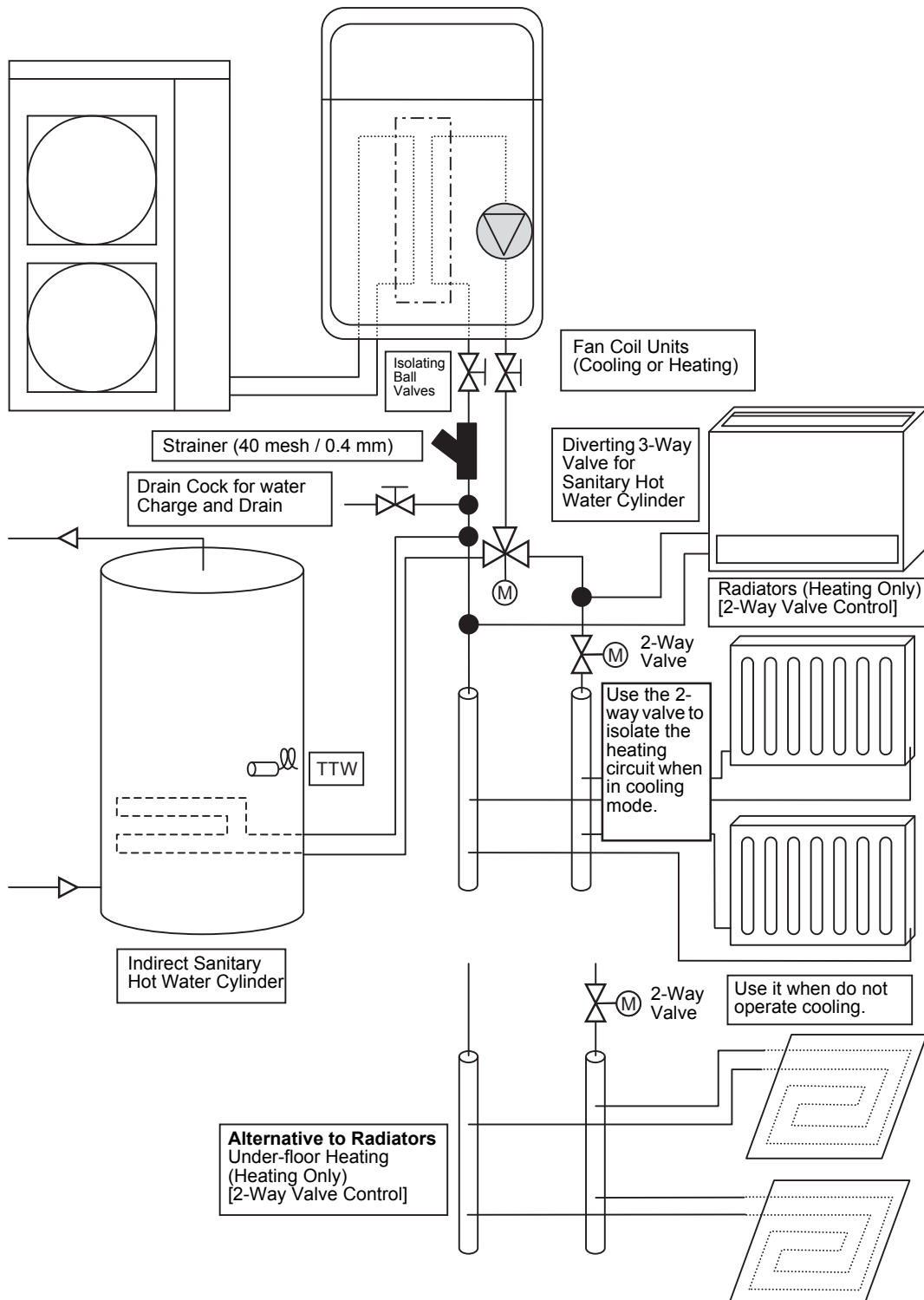

■ Example of 2-zone temperature control and hot water supply system

The following shows an example of the 2-zone temperature control.
 A buffer tank and a water pump are required for the 2-zone temperature control.

▼ Fig. 5-02

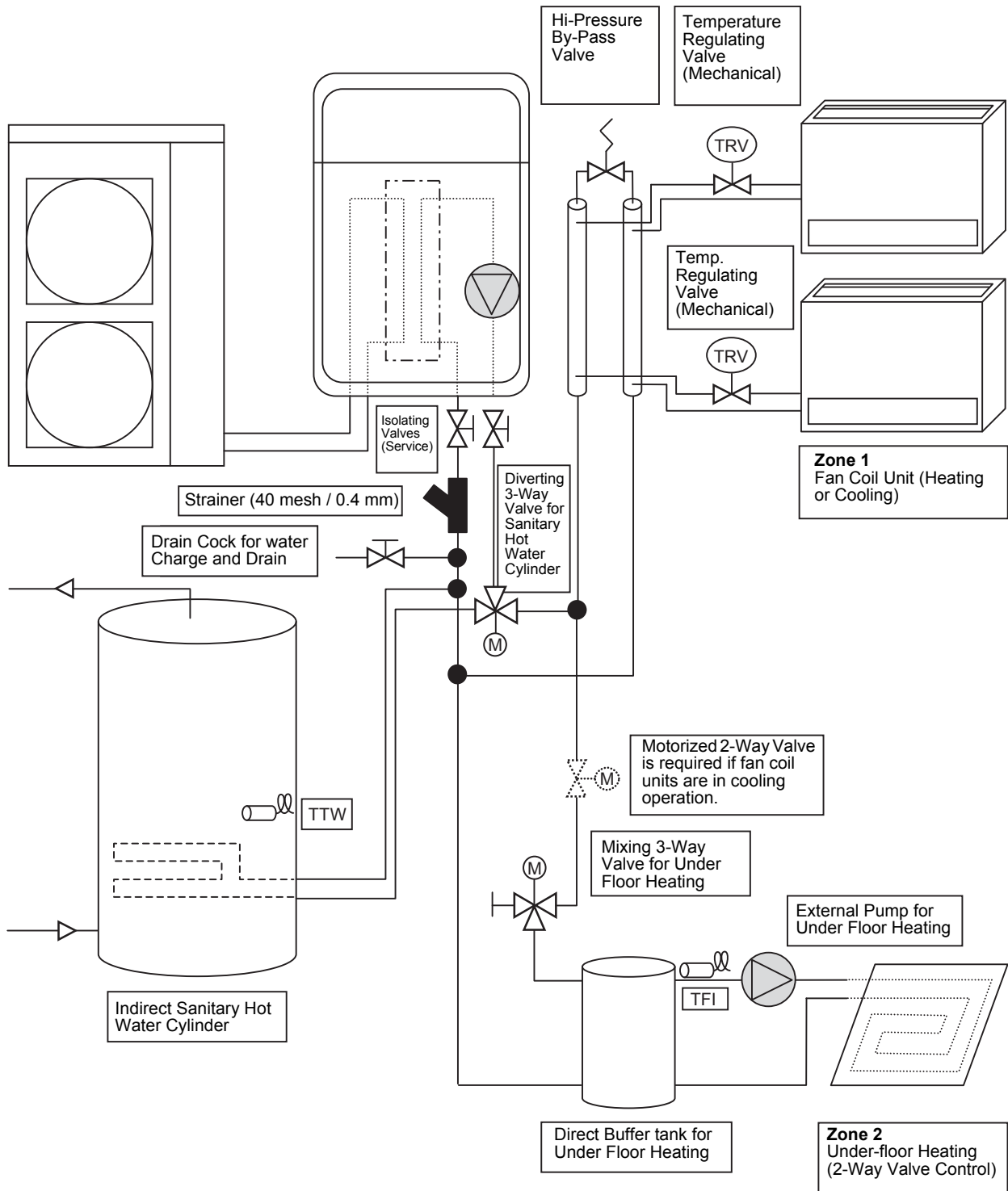

6 Main components of Hydro Unit

■ Exploded view and description for Hydro Unit

▼ Fig. 6-01

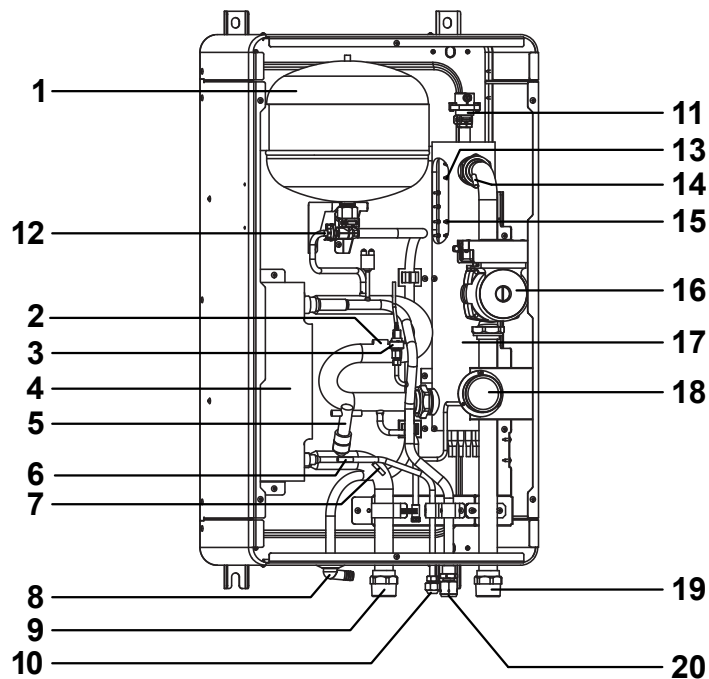

- 1 : Expansion vessel
- 2 : Temperature sensor (for Heat pump outlet -TWO)
- 3 : Pressure sensor
- 4 : Heat exchanger
- 5 : Flow switch (13 L/min (8 kW), 18 L/min (11 kW))
- 6 : Temperature sensor (for refrigerant -TC)
- 7 : Temperature sensor (for water inlet -TWI)
- 8 : Drain nipple
- 9 : Water inlet connection
- 10 : Refrigerant liquid connection
- 11 : Air relief valve
- 12 : Overpressure preventive valve (0.43 MPa (4.3 bar))
- 13 : Thermal protector (auto)
- 14 : Temperature sensor (for water outlet THO)
- 15 : Thermal protector (Single operation)
- 16 : Water pump
- 17 : Backup heater (3 kW, 3 kW x 2, 3 kW x 3)
- 18 : Manometer
- 19 : Water outlet connection
- 20 : Refrigerant gas connection

■ E-box layout

▼ Fig. 6-02

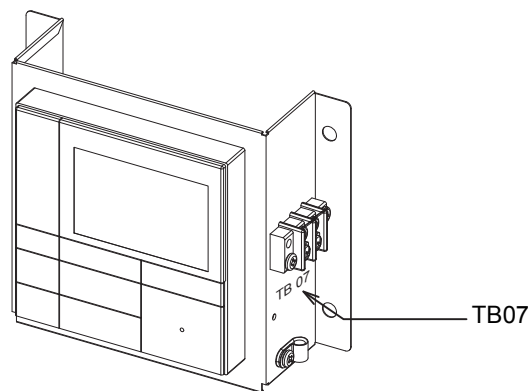
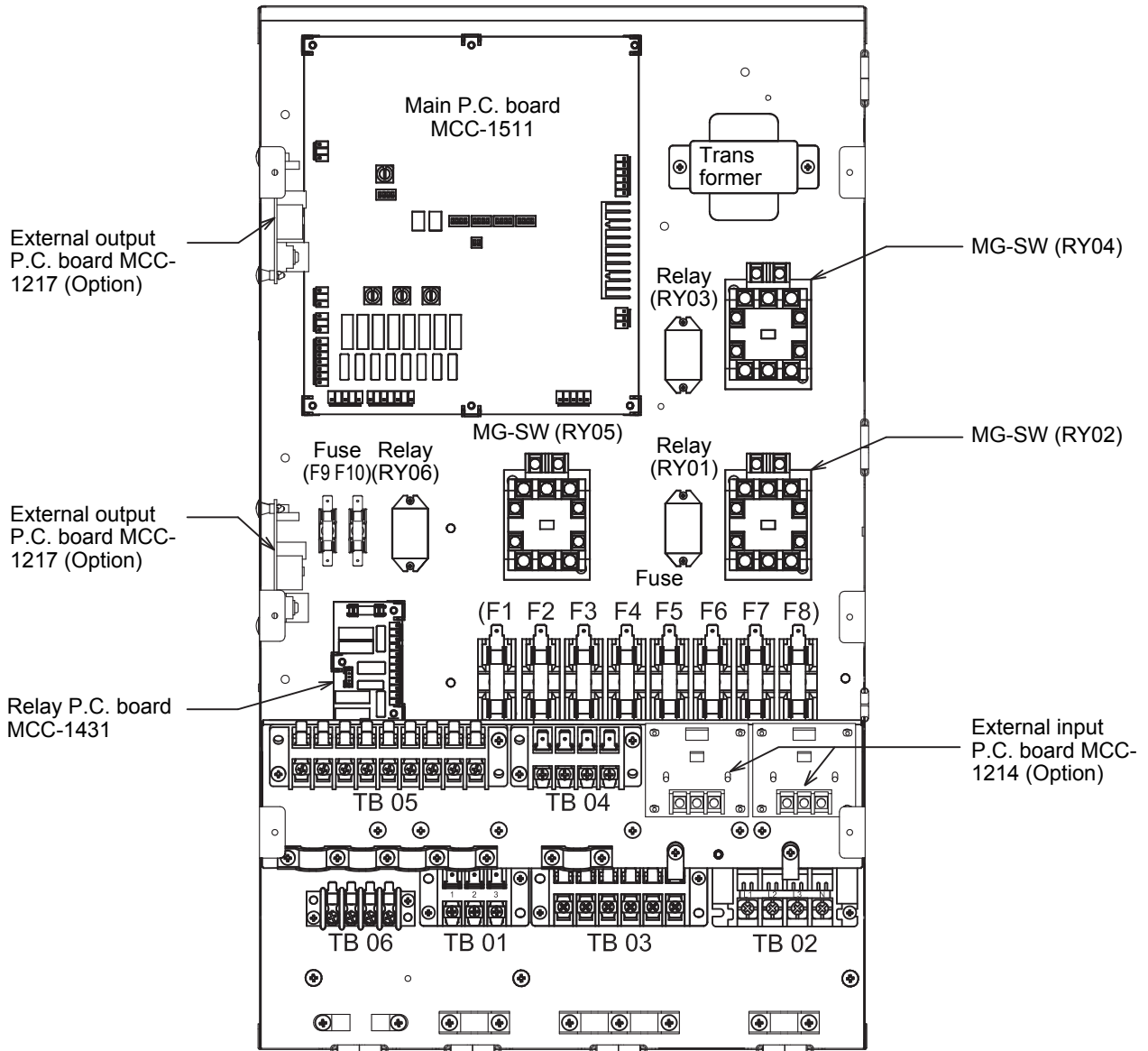

7 Hydro Unit installation

⚠ WARNING

- To protect yourself from injury, always use PPE (Personal Protective Equipment), that is, wear gloves.
- Install the Hydro Unit by at least two persons.
- Install the Hydro Unit in a place strong enough to withstand the following weights:
Hydro Unit weight with no water 49 kg (P805) 52 kg (P1105)
Hydro Unit weight with full water 69 kg (P805) 72 kg (P1105)

⚠ CAUTION

- Do not install the unit in a place where water freezes.
- Do not install the Hydro Unit in a place where combustible gas may leak.
- Do not install the Hydro Unit in a place exposed to rain or water.
- Do not install the Hydro Unit near equipment which generates heat.
- Do not install the Hydro Unit to a movable object.
- Do not install the Hydro Unit in a place exposed to vibration.
- The unit must be installed in accordance with national wiring regulation.
- The Hydro Unit must not be installed in a high humidity condition area.

■ Handling, unpacking, and checking the Hydro Unit

- The unit should be checked when it is delivered, and any damage reported immediately to the courier claims the department.

■ Positioning

Service space

Secure a service space for the Hydro Unit.

- Do not install the Hydro Unit in a place where heat stagnates.

▼ Fig. 7-01

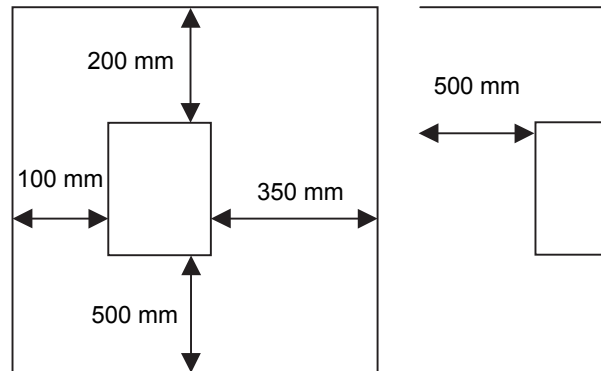

Mounting

Install M10 bolts at the positions shown below and secure them with nuts.

▼ Fig. 7-02

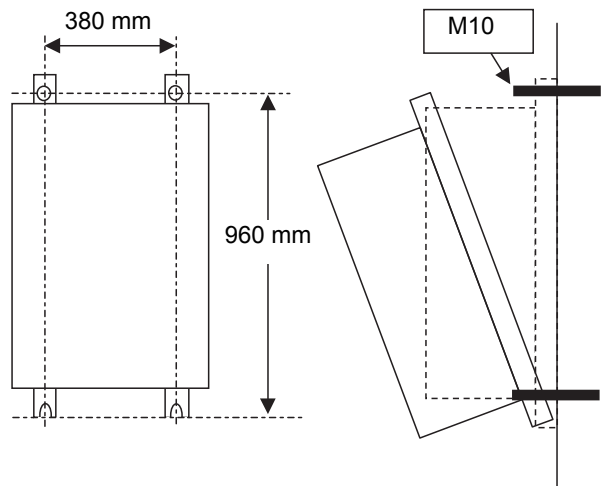

NOTE

If customer worried about vibration of ESTIA, please insert vibration isolating material between the product and the wall, when installing the product.

The Hydro Unit can be installed directly without using the fixing angles.

However, the back side of the Hydro Unit can be highly heated, therefore, the installing surface must be heat-resistant.

▼ Fig. 7-03

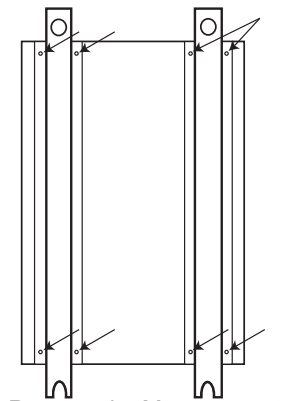

Remove the M5a screws to detach the fixing angles.

▼ Fig. 7-04

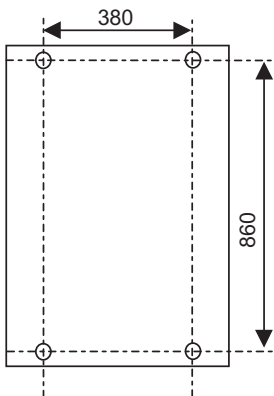

▼ Fig. 7-05

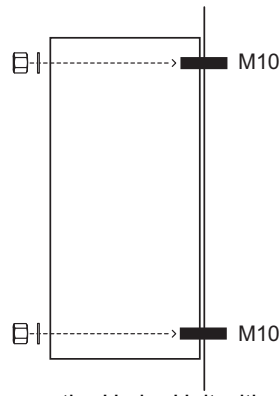

Secure the Hydro Unit with plain washers and nuts.

Install the Hydro Unit so that its tilting angle falls within the range below.

▼ Fig. 7-06

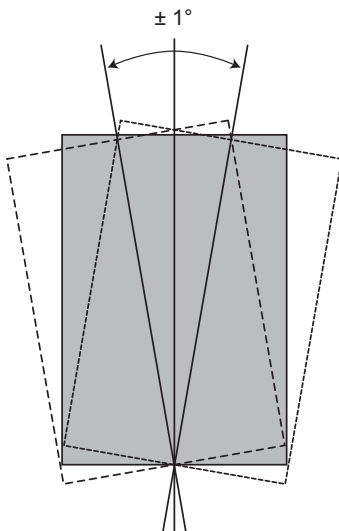

▼ Fig. 7-07

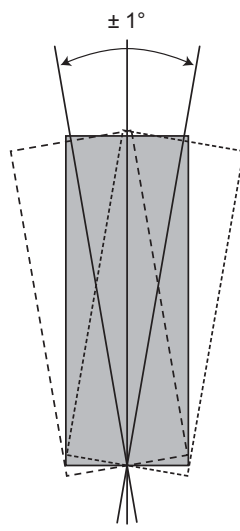

■ Refrigerant piping

⚠ WARNING

- THIS SYSTEM ADOPTS HFC REFRIGERANT (R410A) WHICH DOES NOT DESTROY THE OZONE LAYER.
- The characteristics of R410A refrigerant are: ease to absorb water, oxidizing membrane or oil, and its pressure is approximately 1.6 times higher than that of R22. Accompanied with the new refrigerant the oil has also been changed. Therefore during installation work prevention of the invasion of water, dust, former refrigerant or oil is of a paramount importance. To prevent the charging of incorrect refrigerants into the system the service valve connection ports have also increased in size.
- The use of R410A tools is required for correct installation of the system.
- The use of the correct pipe sizes and wall thicknesses of copper pipe work is required for the correct installation of the system.

⚠ CAUTION

- Ensure all refrigerant pipes are protected from the invasion of dust and water.
- Ensure all pipe work connections are tightened to the required torque settings detailed in this section.
- Perform an air tight using Oxygen Free Nitrogen (OFN) only.
- Evacuate the air in the pipe work using a vacuum pump.
- Check for refrigerant gas leaks at all connections throughout the pipe work.

NOTE

The Air to Water Heat Pump system uses R410A refrigerant. It is important that copper pipes used for refrigerant piping have the following wall thickness:

- 0.8 mm for $\varnothing 6.4$ mm, $\varnothing 9.5$ mm and $\varnothing 12.7$ mm
- 1.0 mm for $\varnothing 15.9$ mm

Refrigeration pipe

The length and height of the refrigeration pipe must be within the following values.
 As long as the Hydro Unit is installed within these ranges, no additional refrigerant is required.

▼ Fig. 7-08

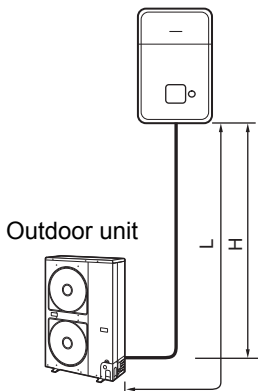

H: Max. ±30 m (above or below)
 L: Max. 30 m
 Min. 5 m

Refrigerant pipe sizes

Hydro Unit Model	Gas Side (mm)	Liquid Side (mm)
8 & 11 kW Hydro Unit	Ø 15.88	Ø 9.52

Flaring

- Cut the refrigerant pipes to the correct length using a pipe cutter. Remove any burrs that may be on the pipes as these may cause refrigerant leaks or component failure in the refrigeration cycle.
- Place the correct size flare nuts onto the pipes (use the flare nuts supplied with the Hydro Unit or use flare nuts designed specifically for R410A refrigerant) and then flare the pipes using the correct flaring tool.

Tightening

- Connect the refrigerant pipes, from the outdoor unit, to the Hydro Unit as shown below.

▼ Fig. 7-09

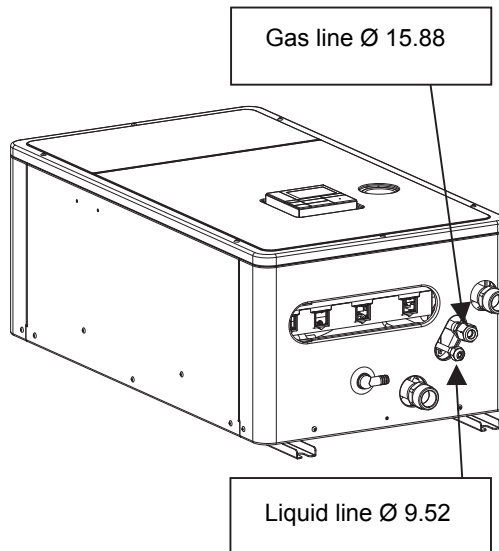

- Align the flare connection on each pipe with the corresponding outlet connection on the Hydro Unit. Tighten the flare nuts, using fingers, to secure the pipes in place.
- Tighten the flare nuts, using a torque wrench, to the tightening torques shown below:

Outer Ø of Copper Pipe (mm)	Tightening Torque (N/m)
9.5	33 to 42
15.9	63 to 77

- To prevent damage, to the refrigerant pipes, use two spanners to tighten the flare nut connections to the required torque.

Water pipe

⚠ WARNING

- Install water pipes according to the regulations of respective countries.
- Install water pipes in a freeze-free place.
- Make sure that water pipes have sufficient pressure resistance.
 The setting value of the overpressure preventive valve is 0.43 MPa. (4.3 bar)

⚠ CAUTION

- Do not use zinc plated water pipes. When steel pipes are used, insulate both ends of the pipes.

- The water to be used must meet the water quality standard specified in EN directive 98/83 EC.

Water pipe

Design the water pipe length within the QH characteristics of the pump (Refer to “Fig. 7-16” and “Fig. 7-17” on page 17).
The height of the pipe must be 7 m or less.

▼ Fig.7-10

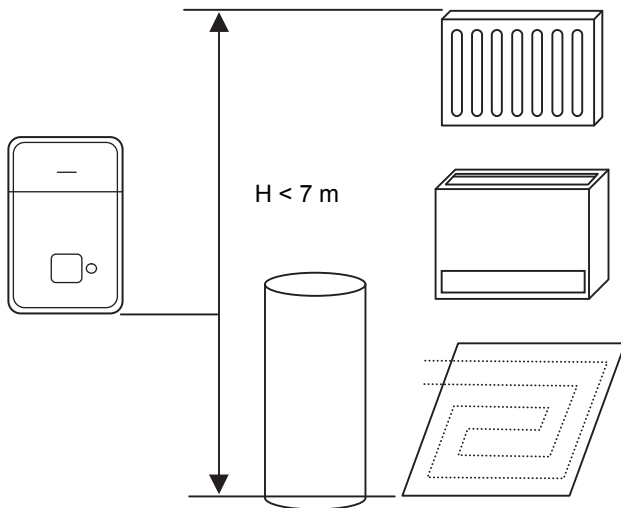

Water circuit

- Install a strainer with 30 to 40 meshes (locally procured) at the water inlet of the Hydro Unit.
- Install drain cocks (locally procured) for water charge and discharge at the lower part of the Hydro Unit.
- Make the piping route a closed circuit. (An open water circuit may cause a failure.)

▼ Fig. 7-11

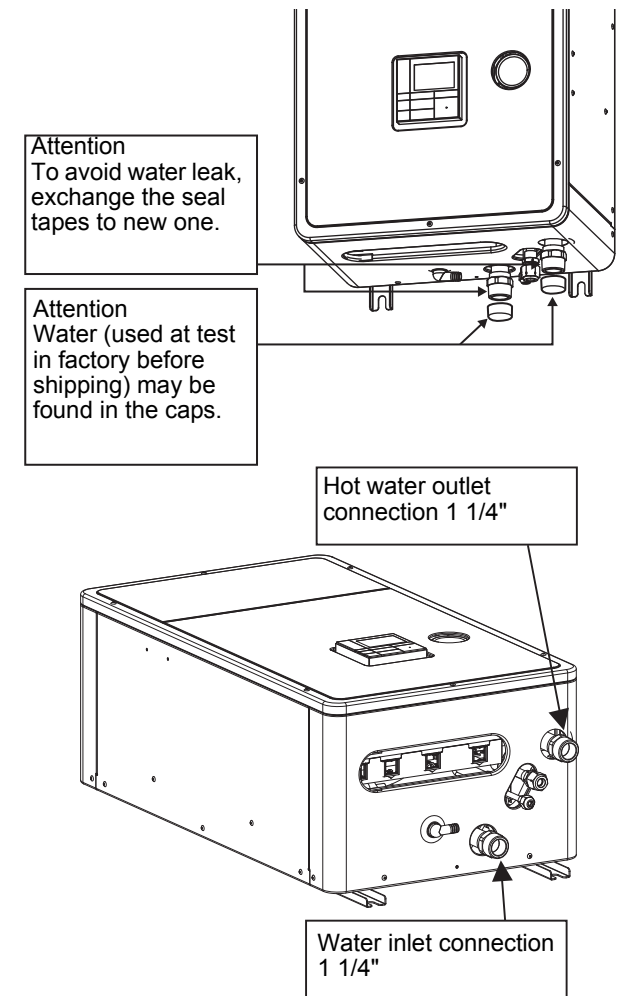

▼ Fig. 7-12

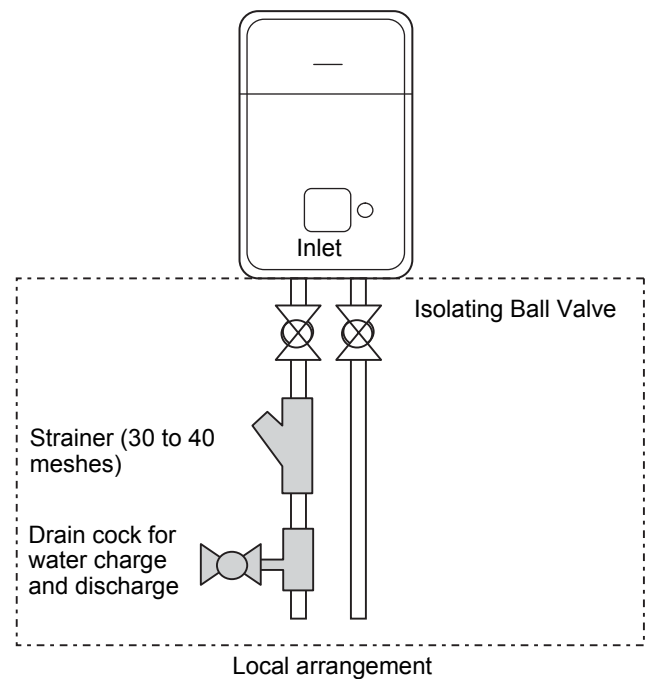

Piping to hot water cylinder (option)

Water supplied to the hot water cylinder is branched by a motorized 3-way valve (locally procured). For the specifications of the motorized 3-way valve, refer to “Control parts specifications” on page 21. Connect the hot water cylinder to port A (open when energized) of the valve.

▼ Fig. 7-13

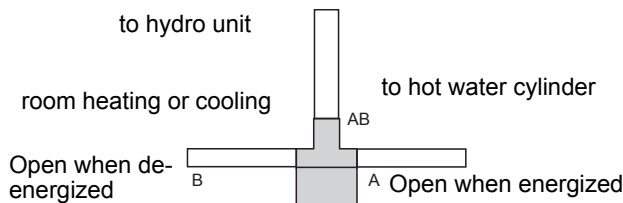

Piping to 2-zone operation

To perform 2-zone temperature control, circulate water by another pump (locally procured) through a motorized mixing valve (locally procured) and a buffer tank (locally procured). For the specifications of the motorized mixing valve, Refer to “Control parts specifications” on page 21.

▼ Fig. 7-14

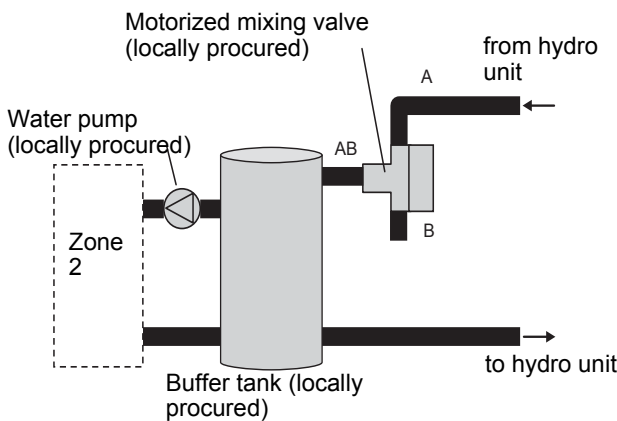

Checking water volume and initial pressure of expansion vessel

The expansion vessel of the Hydro Unit has a capacity of 12 liters. The initial pressure of the expansion vessel is 0.15 MPa (1.5 bar). The pressure of the safety valve is 0.43 MPa (4.3 bar). Verify whether the capacity of the expansion vessel is sufficient using the following expression. If the volume is insufficient, add the capacity locally.

Expression for expansion vessel selection

$$V = \frac{\epsilon \times V_s}{1 - \frac{P_1}{P_2}}$$

- V: Necessary total tank capacity (ℓ)
 - ε: Water expansion coefficient at each hot water temperature
 - Vs: Total water amount in the system
 - P1: System pressure at tank setting position (MPaabs.)
= water supply pressure = 0.3 (MPaabs.) (recommended valve)
 - P2: Maximum pressure used during operation at tank setting position (MPaabs.)
= safety valve setting pressure = 0.4 (MPaabs.)
- * The absolute pressure value (abs.) is obtained by adding the atmospheric pressure (0.1 MPa (1 bar)) to the gauge pressure.

▼ Tank selection method

Water temperature and expansion coefficient			
Hot water temperature (°C)	Expansion rate ε	Hot water temperature (°C)	Expansion rate ε
0	0.0002	50	0.0121
4	0.0000	55	0.0145
5	0.0000	60	0.0171
10	0.0003	65	0.0198
15	0.0008	70	0.0229
20	0.0017	75	0.0258
25	0.0029	80	0.0292
30	0.0043	85	0.0324
35	0.0050	90	0.0361
40	0.0078		
45	0.0100		

▼ Fig. 7-15

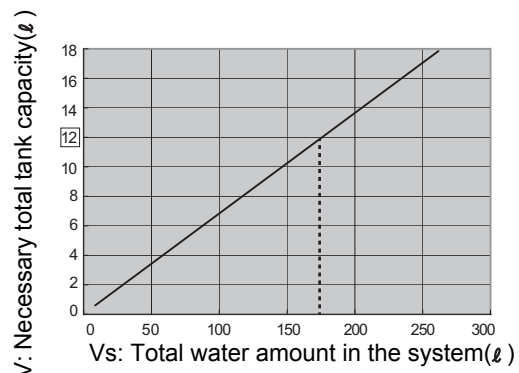

*In case the maximum hot water temperature is 60°C
Install an external expansion vessel when the capacity of the expansion vessel is insufficient.

Pump operation/configuration

▼ Fig. 7-16

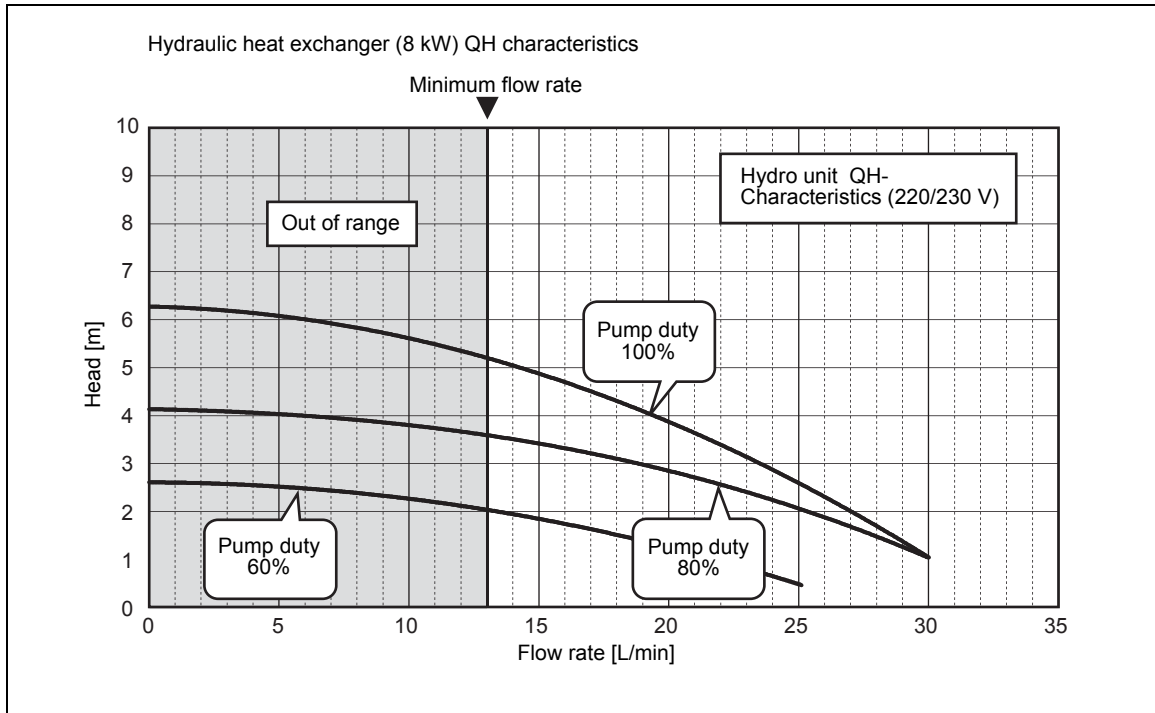

▼ Fig. 7-17

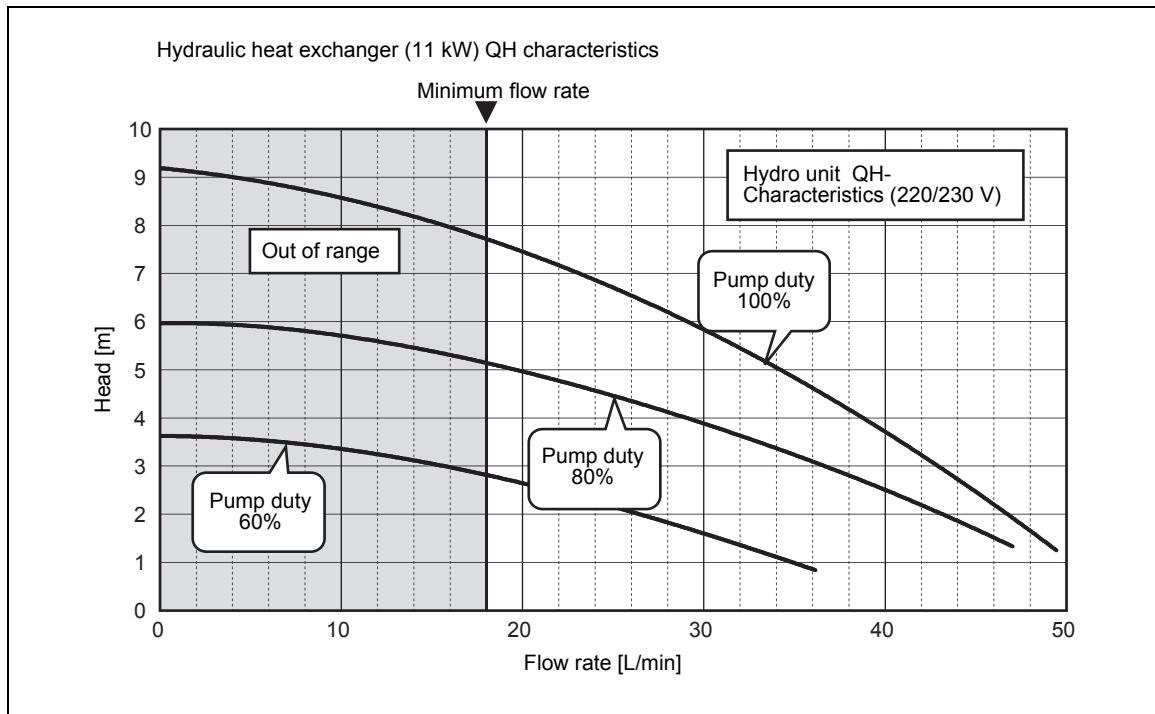

Water charging

Charge water until the pressure gauge shows recommended value 0.2 MPa (2 bar).
Hydraulic pressure may drop when the trial run begins. In that case, add water.
Air may enter if the charged hydraulic pressure is low. Loosen the purge valve cap by two turns to release air.

▼ Fig. 7-18

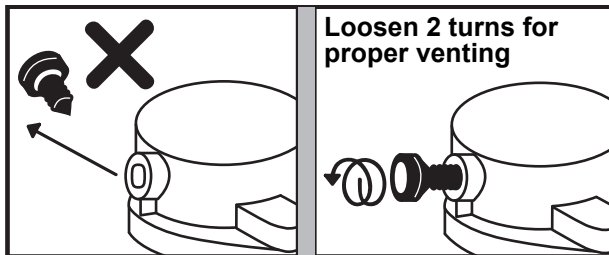

- * Purge valve cap faces the front as factory default.
- * The direction purge valve cap may change during transportation.

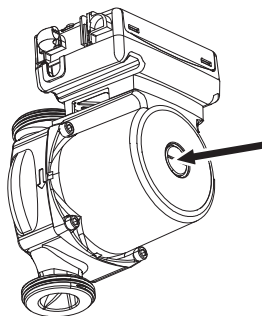

Loosen the air vent screw of the pump, pull out air in the pump, and tighten again.
Loosen the cap of the pressure relief valve to release air.
Water may come out of the pressure relief valve. Release the air completely from the water circuit. Failure to do so may disable correct operation.

Water quality

The water used must satisfy EN directive 98/83 EC.

Piping insulation

It is recommended that insulation treatment be applied to all pipes. To perform optional cooling operation, apply insulation treatment of 20 t or more to all pipes.

■ Electrical installation

⚠ WARNING

- Ensure electrical circuits are isolated before commencing the electrical installation.
- The electrical installation must be completed by a qualified electrician.
- The electrical installation must comply to all Local, National and International electrical installation regulations.
- This product must be earthed in accordance with Local, National and International electrical installation regulations.

⚠ CAUTION

- The Hydro Unit must be connected to a dedicated power supply for the back up heater circuit.
- The electrical supply must be protected by a suitably sized over current protection device (fuse, MCB etc) and an earth leakage protection device.
- The Hydro Unit must be connected to the mains power supply using an isolating switch which disconnects all poles and has a contact separation of at least 3 mm.
- The cord clamps, attached to the Hydro Unit, must be used to secure the electrical cables.
- Wrong connection of electrical cables may result in electrical component failure or fire.
- Ensure the electrical cables are sized in accordance with the installation instructions.

Control line

▼ Fig. 7-19

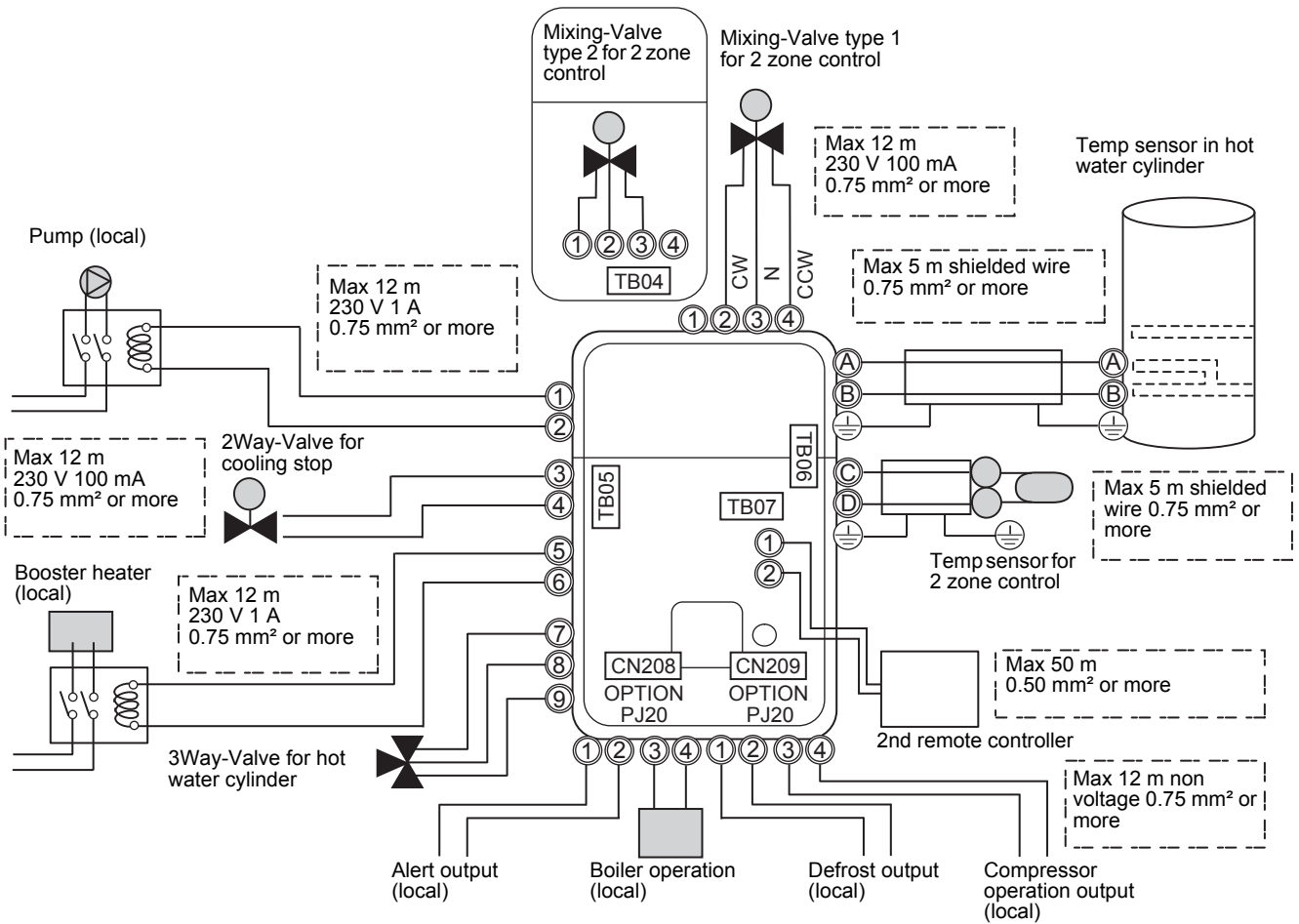

▼ Fig. 7-20

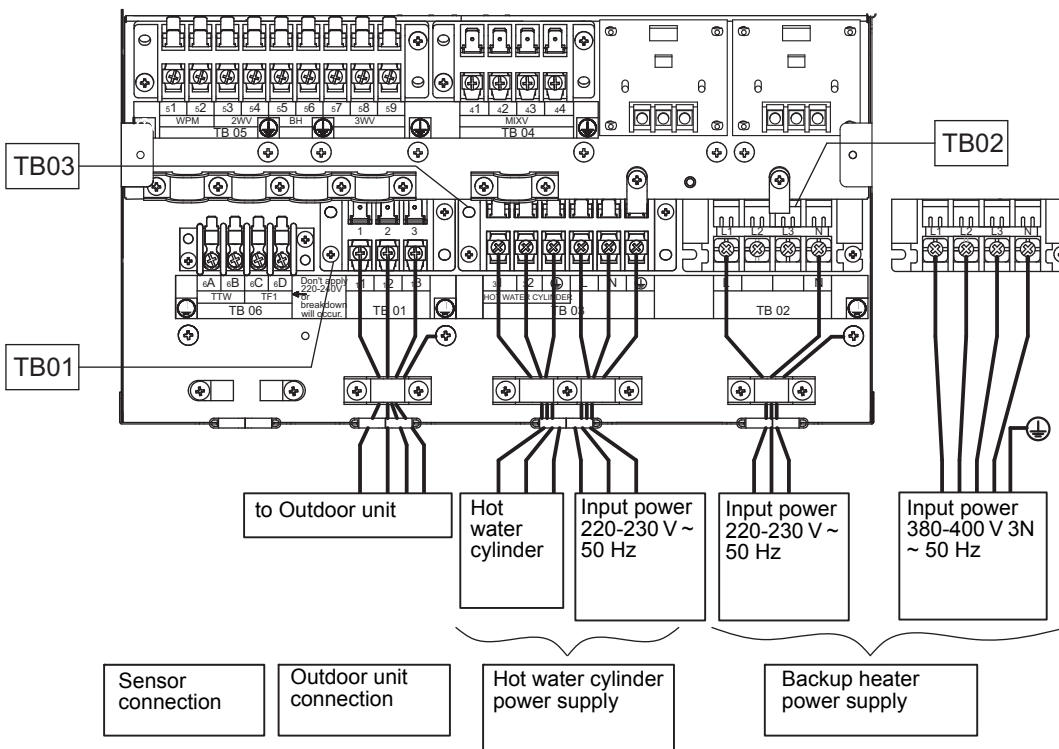

Electrical supply/cable specifications**▼ Wiring specifications**

Description		Model name HWS-	POWER SUPPLY	Maximum current	Installation fuse rating	Power wire	Connection destination		
Outdoor unit power	Power input	P1105HR-E	220-230 V ~ 50 Hz	22.8 A	25 A	2.5 mm ² or more	Ⓐ, Ⓑ		
		P805HR-E	220-230 V ~ 50 Hz	22.8 A	25 A	2.5 mm ² or more			
Hydro inlet heater power	Power input for backup heater	P1105XWHM3-E	220-230 V ~ 50 Hz	13 A	16 A	1.5 mm ² or more	Ⓐ, Ⓑ	TB02	
		P1105XWHT6-E	380-400 V 3N~ 50 Hz	13 A(13 A x 2P)	16 A	1.5 mm ² or more			Ⓐ, Ⓑ, Ⓒ
		P1105XWHT9-E	380-400 V 3N~ 50 Hz	13 A(13 A x 3P)	16 A	1.5 mm ² or more			Ⓐ, Ⓑ, Ⓒ
		P805XWHM3-E	220-230 V ~ 50 Hz	13 A	16 A	1.5 mm ² or more			Ⓐ, Ⓑ
		P805XWHT6-E	380-400 V 3N~ 50 Hz	13 A(13 A x 2P)	16 A	1.5 mm ² or more			Ⓐ, Ⓑ, Ⓒ
		P805XWHT9-E	380-400 V 3N~ 50 Hz	13 A(13 A x 3P)	16 A	1.5 mm ² or more			Ⓐ, Ⓑ, Ⓒ
	Power input for cylinder heater	220-230 V ~ 50 Hz	12 A	16 A	1.5 mm ² or more	Ⓐ, Ⓑ	TB03		
Outdoor-Hydro unit	Connection					1.5 mm ² or more	Ⓐ, Ⓑ, Ⓒ	TB01	
Hydro -Cylinder	Connection					1.5 mm ² or more	Ⓐ, Ⓑ	TB03	

▼ Wiring specifications (control line)

Description	Line spec	Maximum current	Maximum length		Connection destination
3-way valve control	2 line or 3 line	100 mA	12 m	0.75 mm ² or more	Ⓐ, Ⓑ, Ⓒ (TB05)
2-way valve control	2 line	100 mA	12 m	0.75 mm ² or more	Ⓒ, Ⓓ (TB05)
Mixing valve control	3 line	100 mA	12 m	0.75 mm ² or more	Ⓐ, Ⓑ, Ⓒ or Ⓒ, Ⓓ, Ⓔ (TB04)
2-zone thermo sensor	2 line	100 mA	5 m	0.75 mm ² or more	Ⓒ, Ⓓ (TB06)
Cylinder thermo sensor	2+GND(shielded wire)	100 mA	5 m	0.75 mm ² or more	Ⓐ, Ⓑ (TB06)
Second remote controller	2 line	50 mA	50 m	0.5 mm ² or more	Ⓐ, Ⓑ (TB07)
Group control (total)	2 line	50 mA	50 m	0.5 mm ² or more	Ⓐ, Ⓑ (TB07)
Open protocol interface	2 line	100 mA	50 m	0.5 mm ² or more	Ⓐ, Ⓑ (TB07)

▼ Control parts specifications

	Power	Maximum current	Type
Motorized 3-way valve (for hot water)	AC 230 V	100 mA	Default: 2-wire spring return valve or 3 wire SPST valve Note: 3 wire SPDT valve can be used by changing DIP switch 13_1.
Motorized 2-way valve (for cooling)	AC 230 V	100 mA	spring return type (normally open)
Motorized mixing valve (for 2-zone)	AC 230 V	100 mA	Default: Drive time = 60sec to 90° Note: 3 wire SPST or SPDT valves, with drive times between 30 and 240 seconds, can be used. Valve drive time can be changed using function code 0C

▼ Output line specifications

Description	Output	Maximum current	Max voltage	Maximum length	
External pump No.1	AC230 V	1 A	–	12 m	
External boost heater	AC230 V	1 A	–	12 m	Output as required when outdoor air temperature is -20 °C or less
Boiler control	Non-voltage contacts	0.5 A	AC230 V	12 m	Output as required when outdoor air temperature is -10 °C or less. The outdoor air temperature, when the boiler output is enabled, can be changed using function code 23.
		1 A	DC24 V	12 m	
ALARM Output	Non-voltage contacts	0.5 A	AC230 V	12 m	
		1 A	DC24 V	12 m	
Compressor operation output	Non-voltage contacts	0.5 A	AC230 V	12 m	
		1 A	DC24 V	12 m	
Defrost Output	Non-voltage contacts	0.5 A	AC230 V	12 m	
		1 A	DC24 V	12 m	

▼ Input line specifications

Description	Input	Maximum length
Emergency stop control	Non-voltage	12 m
Cooling thermostat input	Non-voltage	12 m
Heating thermostat input	Non-voltage	12 m

CAUTION

Earthing arrangements

The Hydro Unit and related equipment must be earthed in accordance with your local and national electrical regulations. It is essential that the equipment is earthed to prevent the electric shock and damage to the equipment.

Electrical connection to hydro unit

- Remove the front cover and the electrical box cover from the Hydro Unit.
- The Hydro Unit power cable must be sized in accordance with refer to “Electrical supply/cable specifications”.
- Connect the Hydro Unit power cable to Terminal 02 as shown below.

▼ Fig. 7-21

Backup heater 220-230 V ~ type (3 kW type)	Backup heater 380-400 V 3N~ type (6,9 kW type)
--	---

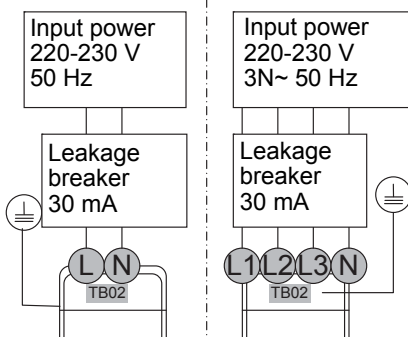

- Ensure the Hydro Unit power cable is secured using the cable clamp fitted in the electrical box.
- Ensure the Hydro Unit power cable connection terminals are tight.

Outdoor unit to hydro unit electrical connection

▼ Fig. 7-22

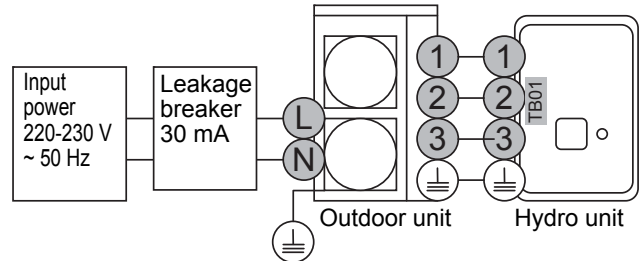

- Ensure electrical circuits are isolated before commencing work.
- The Outdoor Unit to Hydro Unit interconnecting cable must be sized in accordance with refer to “Electrical supply/cable specifications”.
- Connect the Outdoor Unit to Hydro Unit interconnecting cable as shown in the diagram above.
- Ensure the Outdoor Unit to Hydro Unit interconnecting cable is secured using the cable clamp fitted in the electrical box.
- Ensure the Outdoor Unit to Hydro Unit interconnecting cable connection terminals are tight.

Electrical connection for external booster heater

CAUTION

- The maximum current available from the booster heater output is 1 A. Do not connect the booster heater directly to Terminal Block 05 on the Hydro Unit. A separate contactor, supplied locally, must be used to supply the booster heater.
- The booster heater can be installed only for room heating and cannot be used for hot water supply.
- Install the booster heater downstream of the 3-way valve on the indoor unit side.
The booster heater is an external heater, supplied locally, used to assist the Hydro Unit during low ambient conditions.
- The AC230 V 1 A output from the Hydro Unit must only be used to energize an external contactor. (Supplied locally)
- The output from the Hydro Unit is only enabled when the outdoor air temperature is less than -20 °C.
- Ensure the external booster heater is installed and set up in accordance with all Local, National and International regulations.

- Connect the external booster heater to the Hydro Unit in accordance with the diagram shown below.
- Connect the coil, of the field supplied contactor, to terminals 5 & 6 on Terminal Block 05. The contactor will energize in the event of low ambient conditions.
- A separate dedicated electrical supply must be used for the external booster heater. This must be connected through the contacts on the field supplied contactor.

▼ Fig. 7-23

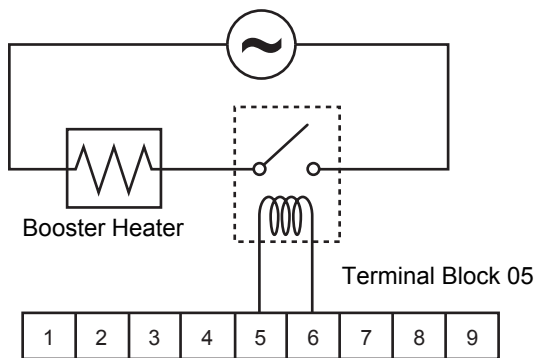

Electrical connection for external additional pumps

- The Hydro Unit has the facility to connect an additional circulating pump, if required, into the heating or cooling system.
- There is an output available from the Hydro Unit. AC230 V 1 A (maximum) is available from each output. The output for each additional pump is synchronized with the operation of the main circulating pump inside the Hydro Unit.
- Connect the additional pumps as shown in the diagram below.
- Connect external pump 1 to terminals 1 & 2 on Terminal Block 05.
- Install external pumps so that their motive power does not affect the internal pump.

▼ Fig. 7-24

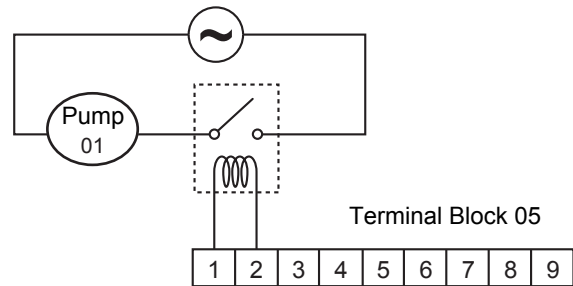

3-way valve (diverter) connection

Required Valve Specification:

Electrical Specification: 230 V; 50 Hz; <100 mA

Valve Diameters: Port A, Port B: Ø 1 1/4"

Return Mechanism: 3 types of 3-way valve (diverter) can be used.

Set the 3-way valve in use with the DIP switch SW13-1 on the Hydro Unit board.

		SW13-1
Type 1	2-wire spring return	OFF
Type 2	3-wire SPST	OFF
Type 3	3-wire SPDT	ON

NOTE

Continuous operation of the valve motor at the fully open position is not recommended.

- The 3-way diverter valve is used to select either domestic hot water or space heating.
- Connect the 3-way diverter valve to terminals 7, 8 and 9 on Terminal Block 05.
- Connect the 3-way diverter valve in accordance with the diagram below:

▼ Fig. 7-25

Type 1: SPRING RETURN

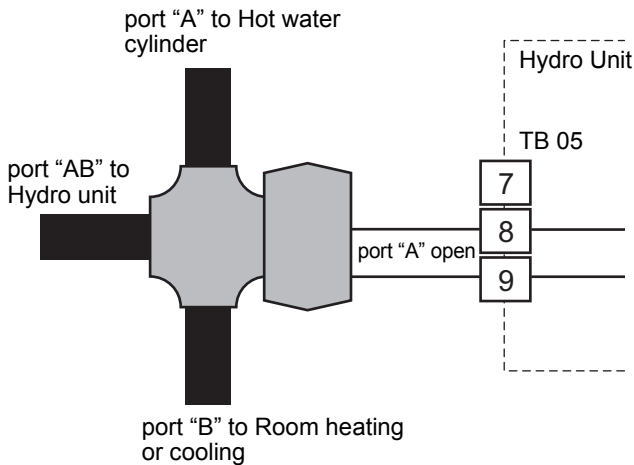

▼ Fig. 7-26

Type 2: SPST

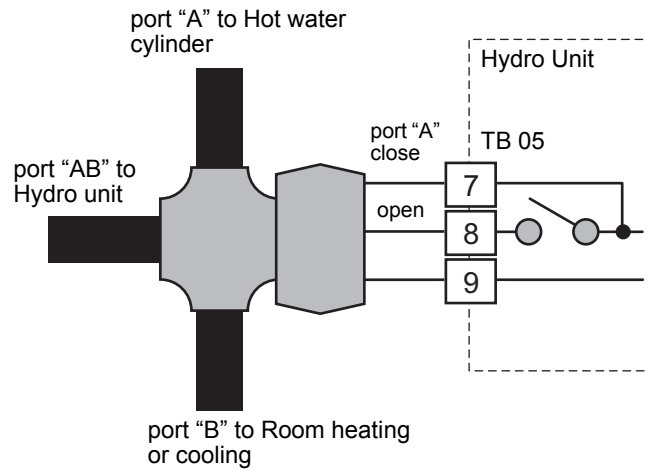

▼ Fig. 7-27

Type 3: SPDT

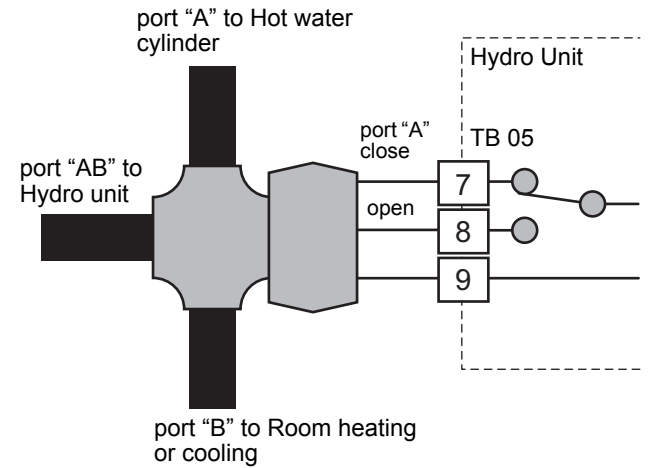

3-way mixing valve connection

Required Actuator Specification

Electrical Specification: 230 V; 50 Hz; <100 mA

The 3-way mixing valve is used to achieve the temperature differential needed in a 2-zone heating system.

- Connect the 3-way mixing valve to terminals 2, 3 and 4 on Terminal Block 04 (for Type 1 mixing valve) or on terminals 1, 2 and 3 on Terminal Block 04 (for Type 2 mixing valve).
- Connect the 3-way mixing valve in accordance with the diagrams below:

▼ Fig. 7-28

Type 1: SPDT

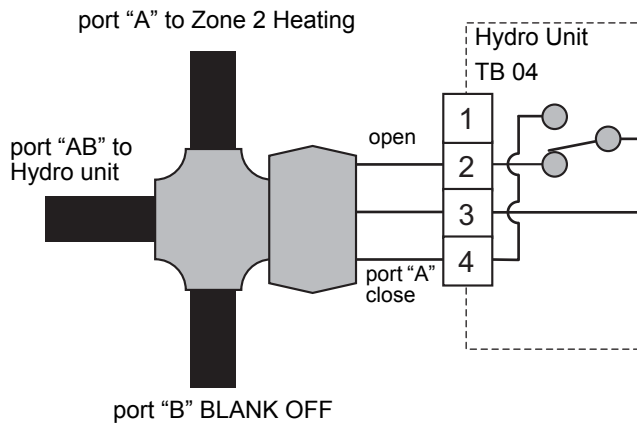

▼ Fig. 7-29

Type 2: SPST

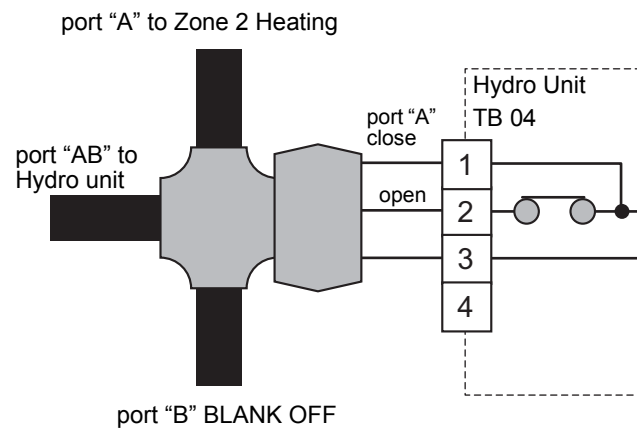

Hot water cylinder connection (optional)

- Please refer to “Electrical supply/cable specifications” for fuse/cable size and for connection details.

Electrical Connection (Hot Water Cylinder Electric Heater)

- The electric heater, incorporated in the hot water cylinder, requires a separate supply to Hydro Unit.
- Connect the hot water cylinder heater electrical supply in accordance with shown below:
Live conductor: Terminal L on Terminal Block 03
Neutral conductor: Terminal N on Terminal Block 03
Earth Conductor: Earth terminal on Terminal Block 03
- Connect the hot water cylinder heater to the Hydro Unit as shown below:
Live conductor to hot water cylinder: Terminal 1 on Terminal Block 03
Neutral conductor to hot water cylinder: Terminal 2 on Terminal Block 03
Earth conductor to hot water cylinder: Earth terminal on Terminal Block 03

▼ Fig. 7-30

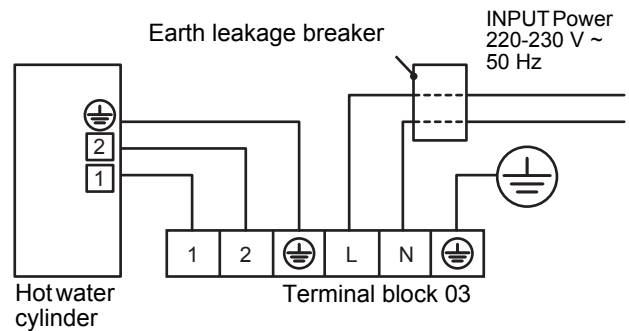

Electrical Connection (Hot Water Cylinder temperature Sensor)

- Connect the hot water cylinder temperature sensor as shown below to terminals A & B on Terminal Block 06 in the Hydro Unit.
- Please ensure that the interconnecting cable, between the Hydro Unit and the hot water cylinder, is connected to earth at both ends of the cable using the shield wire.

▼ Fig. 7-31

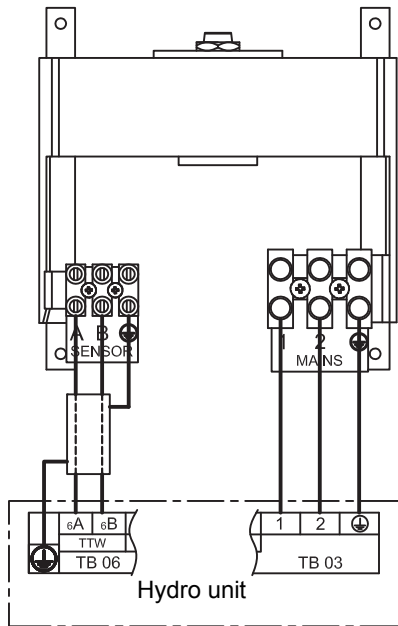

Additional hydro unit outputs

Alarm and Boiler Outputs

Alarm Output: L1: Alarm output

- Output enabled when the system is in alarm/fault condition.
- Volt free contact - specification shown below:
AC230 V; 0.5 A (maximum)
DC24 V; 1 A (maximum)
- Connection details: Terminals 1 and 2 (OPERATION) on MCC-1217 TB (Refer to “Fig. 7-32”)

Boiler Control Output: L2: Boiler drive permission output

- Output enabled when outdoor ambient temperature <-10 °C
- Volt free contact - specification shown below:
AC230 V; 0.5 A (maximum)
DC24 V; 1 A (maximum)
- Connection details: Terminals 3 and 4 (EMG) on MCC-1217 TB (Refer to “Fig. 7-32”)

▼ Fig. 7-32

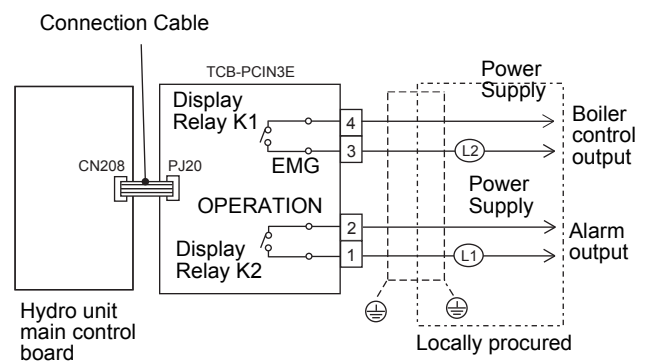

Defrost and Compressor operation Outputs

Defrost output

- Display relay is ON when the system defrost.
- Volt free contact
AC230 V; 0.5 A (maximum)
DC24 V; 1 A (maximum)
- Connection details: Terminals 1 and 2 (OPERATION) on MCC-1217 TB (Refer to “Fig. 7-33”)

Compressor operation output

- Display relay is ON with outdoor unit compressor operation.
- Volt free contact
AC230 V; 0.5 A (maximum)
DC24 V; 1 A (maximum)
- Connection details: Terminals 3 and 4 (EMG) on MCC-1217 TB (Refer to “Fig. 7-33”)

▼ Fig. 7-33

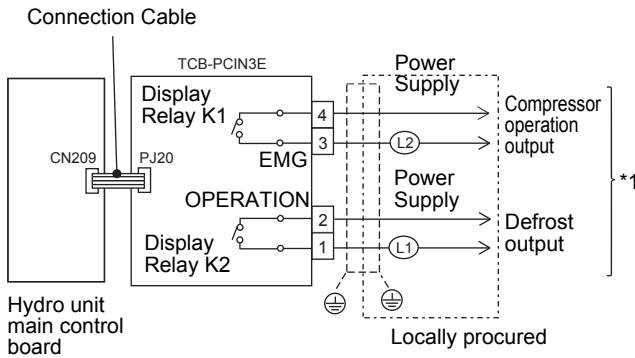

*1: Available to change the output signal by function code 67.

Default (FC67 = 0)	Setting value (FC67 = 1)
1 - 2 = Defrost output 3 - 4 = Compressor operation output	1 - 2 = Alarm output 3 - 4 = During operation

CAUTION

- Be sure to prepare a non-voltage contact for each terminal.
- Display Relay capacity of “EMG” and “OPERATION”.
Below AC230 V 0.5 A (COS Ø = 100%)
When connecting loads such as relay coil to “L1, L2” load, insert noise surge absorber.
Below DC24 V 1 A (Non-inductive load)
When connecting load such as relay coil to “L1, L2” load, insert the bypass circuit.

Optional inputs to hydro unit

Room Thermostat Input:

- 2–3: Room thermostat input for cooling mode
- 1–3: Room thermostat input for heating mode
- Output enabled when either heating or cooling mode selected on room thermostat. (locally supplied)
- Volt free contacts
- Connection details:
Cooling Connection: Terminals 3 (COM) and 2 (COOL) on MCC-1214TB (Refer to “Fig. 7-34”)
Heating Connection: Terminals 3 (COM) and 1 (HEAT) on MCC-1214TB (Refer to “Fig. 7-34”)
- Setting of DIP switch on the Hydro Unit board:
DIP SW02_4 = ON

▼ Fig. 7-34

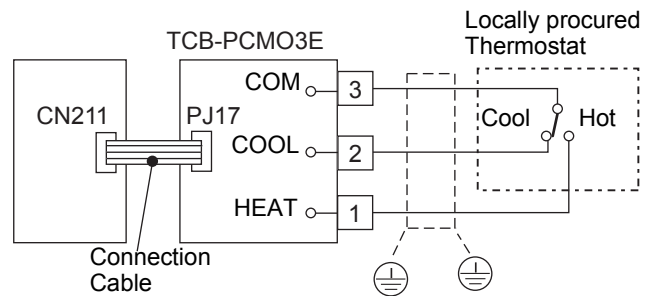

Thermostat operation

	Cooling		Heating	
	on	off	on	off
2 - 3	open	close	–	–
1 - 3	–	–	close	open

CAUTION

- Be sure to prepare a non-voltage continuous contact for each terminal.
- Supplementary Insulation must be added to user touchable part of switches.

Emergency Shutdown input

S2: Emergency stop input, Tempo* control input
 This function can be switched over with FC21 and FC61.

- Non-voltage contacts
- Connection details:
 Emergency stop, Tempo* control ON: Terminals 3 (COM) and 1 (HEAT) on MCC-1214TB (Refer to “Fig. 7-35”)

* a price contract provided by French electric power company EDF

Hot water tank thermostat input

S1: Local hot water tank thermostat input
 This function is used with DIP switch 2_3 is “ON”, when the customer use the local hot water tank.

- * Close: Not reached setting temperature.
- * Open: Reached setting temperature.
 (Refer to “Fig. 7-35”)

Control of force stop and restart

S1: Hot water supply control
 S2: Heating control

- This function is valid only when DIP switch 2_3 is “OFF”, FC61 is set to “3” and FCB6 is set to “1”.
- Operation by external input can be switched over with FC52.

▼ Fig. 7-35

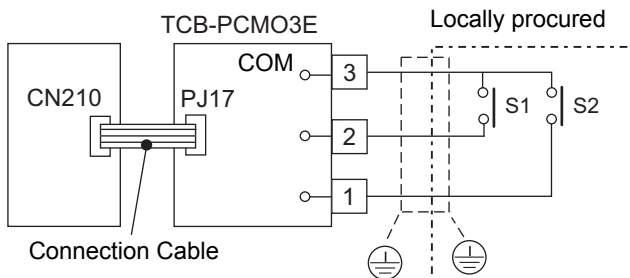

CAUTION

- Be sure to prepare a non-voltage continuous contact for each terminal.
- Supplementary Insulation must be added to user touchable part of switches.

Electrical safety checks

The electrical safety checks must be completed before turning on the electrical supplies to the Air to Water heat pump system. The electrical safety checks should be completed by a qualified electrician. All results measured should comply with your local/national electrical installation regulations.

Earth continuity test

On completion of the electrical installation a resistance test should be completed on the earth conductor to ensure continuity between all pieces of equipment on the earth conductor.

Insulation resistance test

This test must be completed using a 500 V D.C. insulation resistance tester. Insulation resistance tests should be completed between each live terminal and earth.

Second remote controller (option)

Installation place

- Install the remote controller at a height of 1 to 1.5 m from the floor so that the average temperature in the room can be detected.
- Do not install the remote controller in a place exposed to direct sunlight or direct outside air, such as the side of a window.
- Do not install the remote controller in a place behind something or to the rear side of an object, where air flow is not sufficient.
- Do not install the remote controller in a freezing box or refrigerator, as the remote controller is not waterproof.
- Install the remote controller vertically to the wall.

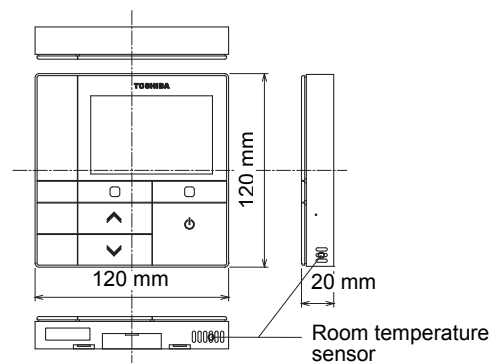

Installation dimension

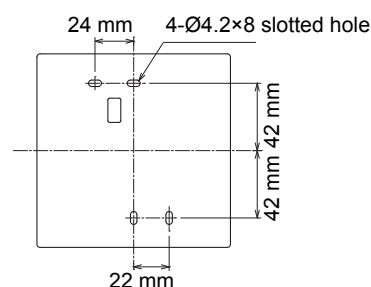

Remote controller installation

NOTE

- Wiring for the remote controller should not be bundled or installed in the same conduit with a power cable.; otherwise, malfunction may result.
- Install the remote controller away from sources of electrical interference and electromagnetic fields.

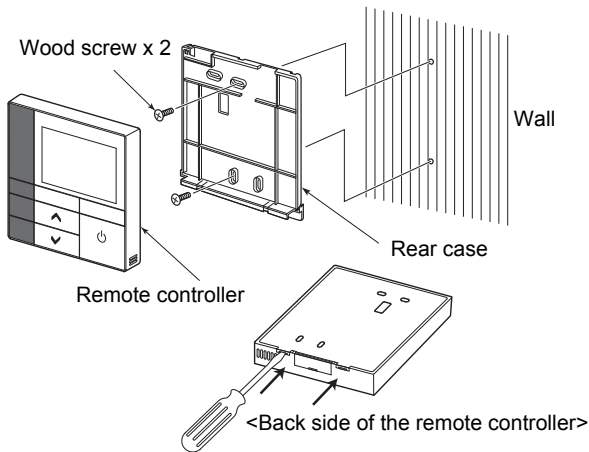

1. Insert a flat-blade screwdriver into the groove on the back side of the remote controller to remove the rear case.
2. Use the wood screws (2 pieces) supplied with the remote controller to attach the rear case of the remote controller to the wall. Do not use an electrical screwdriver. Do not over-tighten the screw (Tightening torque is up to 2 kg / f•cm.); otherwise, the rear case may be damaged.
3. Connect the electrical wire from the hydro unit to the terminal block of remote controller. (Refer to “■ Wire the remote controller”.) **Check the terminal number of electrical wire from the hydro unit to avoid miswiring. (If AC 220-230 V is applied, the remote controller and hydro unit will break down.)**

■ Wire the remote controller

Wiring diagram

Terminal block (TB07) for the remote control wiring on the hydro unit

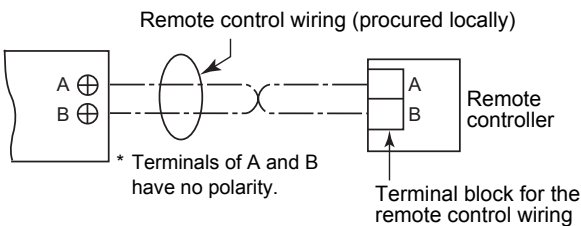

- * Use wire of 0.5 mm² to 2.0 mm².
- * A crimp-style terminal cannot be used.

Second remote controller installation requirements

Installation

For a dual remote controller system, install the remote controllers in the following way.

1. Set one of remote controllers as the header remote controller. (Remote controller of hydro unit is preset as Header.)
2. Set from “Header / Second” in “Initial setting” on the setting screen.

- To control room temperature instead of water temperature with this remote controller, set function code “40” of hydro unit to “1”.

Basic wiring diagram

NOTE

Terminals of A and B have no polarity.

To diverge from the hydro unit

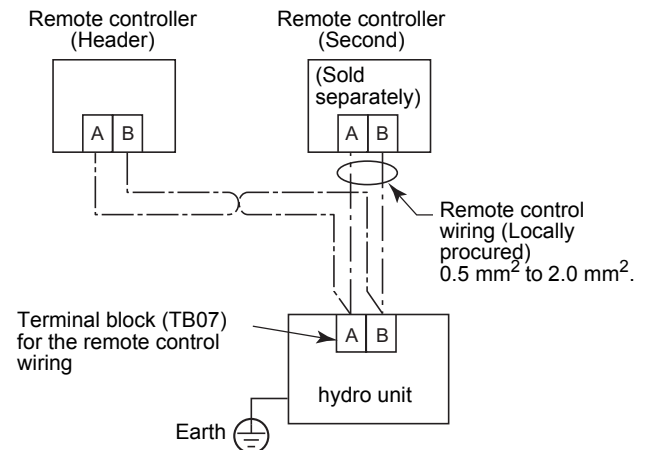

8 Group Control

To operate a group control of multiple hydro units

- Hydro units are available to connect maximum 8 units.
- The wiring of remote controller on the hydro unit. No.2 to No.8 should be cut as shown Fig. 8-01.
- Set the address No. of the Rotary switch "SW01" on the hydro unit PC board as 2 to 8 for the hydro unit No.2 to No.8. The master hydro unit with the Header remote controller should be set as "1". All the units operate according to the header remote controller. Please make all the DIP switches in regard to the operation mode to the same setup.
- Remote controllers are available to connect maximum 2 units as header and second controller.

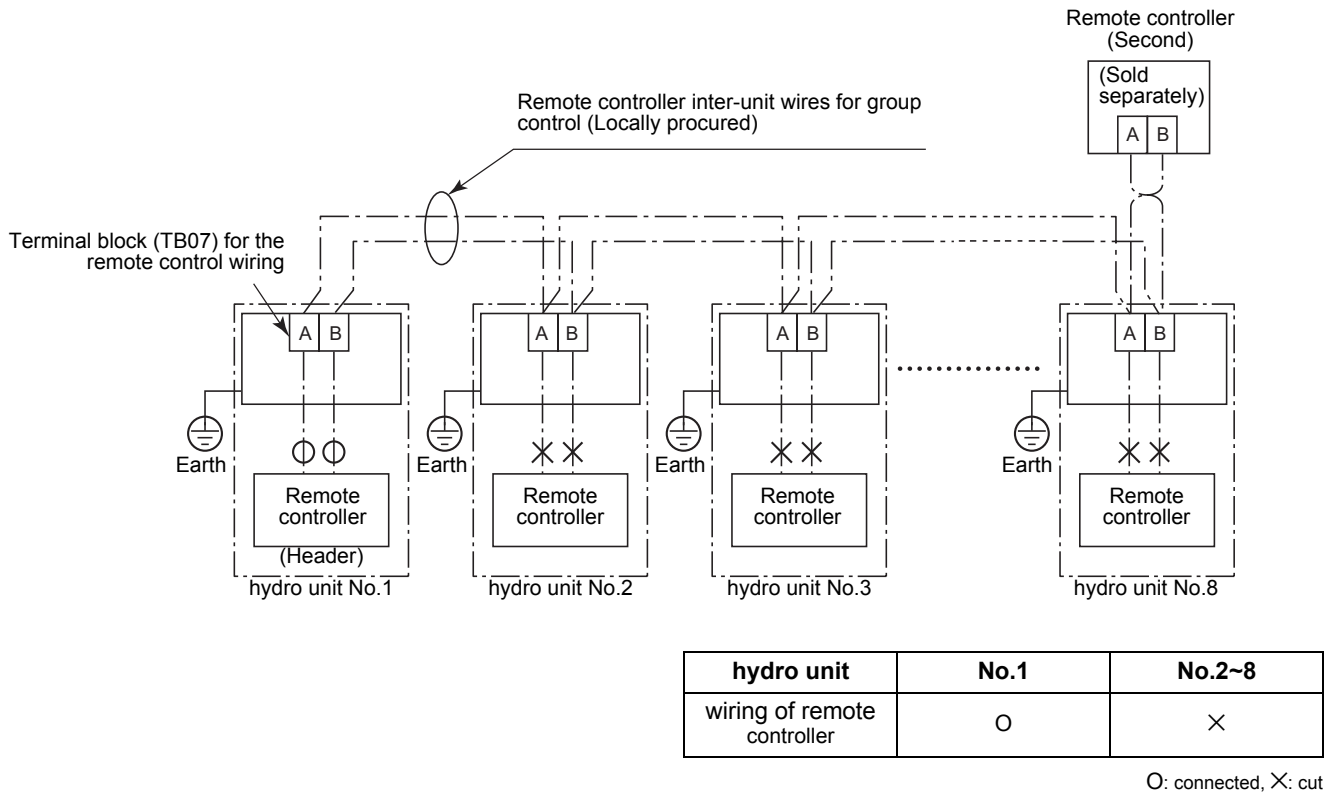

▼ Fig. 8-01

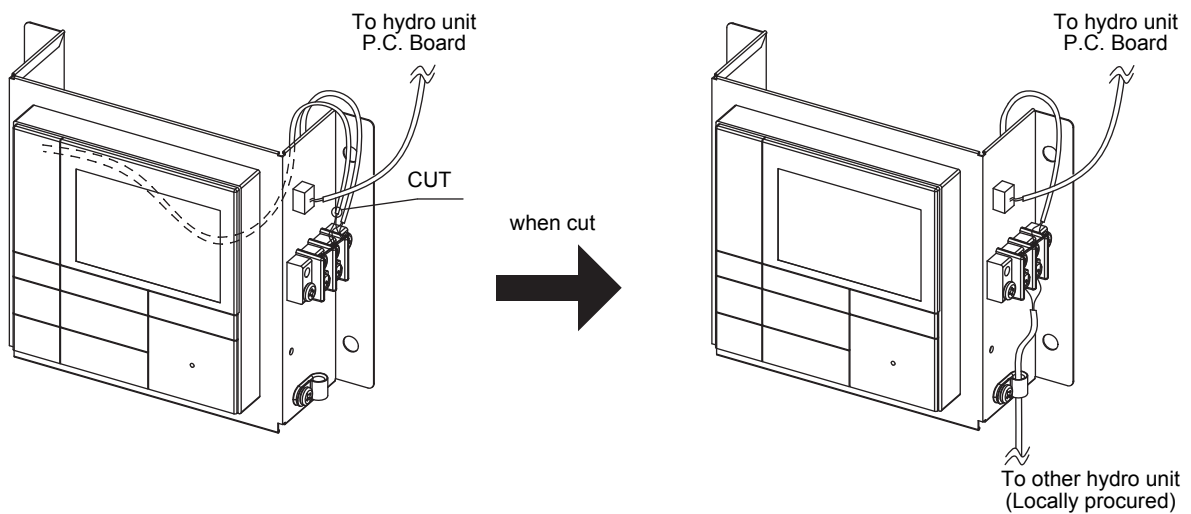

9 Start up and configuration

Set the DIP switches and function codes.

■ Setting DIP switches on the board in the Hydro Unit

- Detach the front cover and the electrical control box cover of the Hydro Unit.
- Set the DIP switches on the main board.

▼ Fig. 9-01

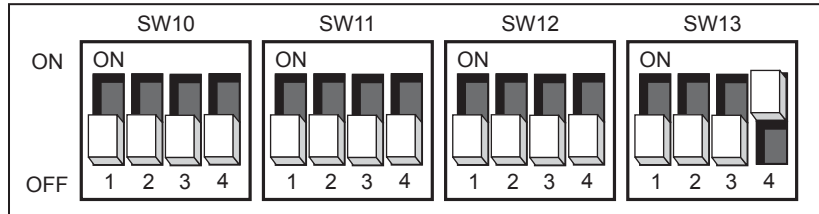

SW No.	DIP No.	Description	Default	After Commissioning	Change 1	Change 2	Change 3
02	1	Boiler install location OFF = Heating side after 3 way valve ON = Before 3 way valve	OFF				
	2	Not Used	–	–	–	–	–
	3	Used to when an external cylinder thermostat is connected OFF = No external cylinder thermostat; ON = External tank thermostat connected	OFF				
	4	Used to when an external room thermostat is connected OFF = No external room thermostat; ON = External room thermostat connected	OFF				
10	1	P1 Pump operation for hot water OFF = synchronised with heat pump ON = Normally run	OFF				
	2	P1 Pump operation for heating OFF = Normally run ON = Stopped at the outside temperature over 20 °C	OFF				
	3	Synchronisation of Pump P2. OFF = P1 synchronised with pump P1 ON = P2 continuous operation (pump off when remote controller switched off)	OFF				
	4	Pump P1 power of regular, When long-term thermo-off. OFF = None operation ON = regular power	OFF				
11	1	Used to activate Hydro Unit back up heaters. OFF = Back up heaters activated; ON = back up heaters de-activated	OFF				
	2	Used to activate hot water cylinder electrical heater. OFF = hot water cylinder heater activated; ON = hot water cylinder heater de-activated	OFF				
	3	Used to activate external booster heater output. OFF = external booster heater output activated; ON = external booster heater output de-activated	OFF				
	4	Not Used	–	–	–	–	–

SW No.	DIP No.	Description	Default	After Commissioning	Change 1	Change 2	Change 3
12	1	Used when a hot water cylinder is connected to system. OFF = hot water cylinder connected; ON = hot water cylinder not connected	OFF				
	2	Used to activate Zone 1 Operation. OFF = Zone 1 activated; ON = Zone 1 de-activated	OFF				
	3	Used to activate Zone 2 Operation. OFF = Zone 2 de-activated; ON = Zone 2 activated	OFF				
	4	Not Used	–	–	–	–	–
13	1	Used to determine type of 3 way diverting valve used on system. OFF = 2 wire/spring return or SPST type valve; ON = SPDT type valve	OFF				
	2	Used to activate external boiler output. OFF = external boiler output de-activated; ON = external boiler output activated	OFF				
	3	Used to activate system auto restart after power failure. OFF = auto restart activated; ON = auto restart de-activated	OFF				
	4	Not Used	ON	–	–	–	–

■ Names and functions of parts

Buttons

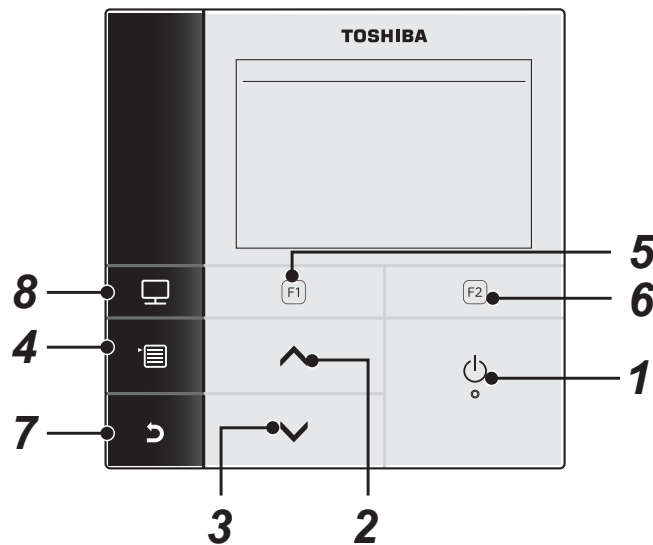

1 [ **ON/OFF**] button

2 [] button

On the top screen: Adjusts the temperature.

On the menu screen or other screen: Selects a menu item or ON/OFF of each function or moves a cursor, etc.

3 [] button

On the top screen: Adjusts the temperature.

On the menu screen or other screen: Selects a menu item or ON/OFF of each function or moves a cursor, etc.

4 [ **MENU**] button

On the top screen: Displays the MENU screen.

On the other screen: Fixes or copies setting the parameter value.

5 [] button

On the top screen: Select the heating or cooling mode.

On the other screen: Varies its function according to the screen.

6 [] button

On the top screen: Select the hot water mode.

On the other screen: Varies its function according to the screen.

7 [ **RETURN**] button

Returns to the previous screen, etc.









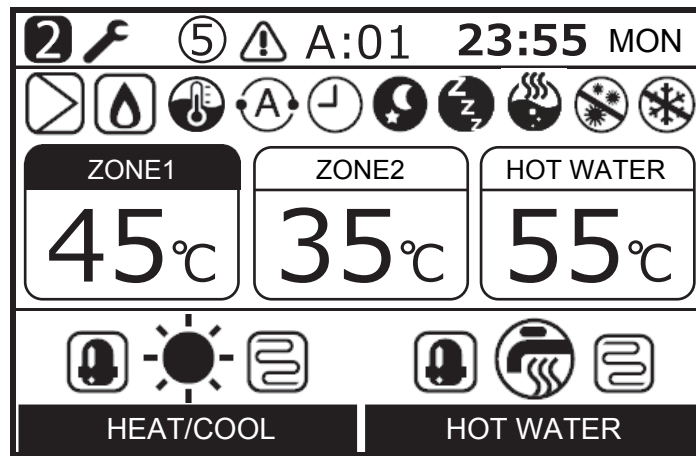



8 [ **MODE**] button









On the top screen: Select the mode for which to change the temperature.

On the other screen: Resets the setting parameter value.





■ Meaning of Indication on the top screen



ZONE1	Lights when floor heater or radiator is connected (when the system has floor heater or radiator).
ZONE2	Lights when controlling the second temperature (It may not light depending on the system).
HOT WATER	Lights when hot water supply system is connected (when the system has hot water supply).
ZONE1	The painted mark lights for operation mode for which temperature is to be changed.
 HEAT/COOL	Lights when the compressor is acting for heating or cooling operation.
 HEAT/COOL	Lights while the electric heater inside the hydro unit is energized during a heating operation.
 HOT WATER	Lights while the compressor is acting for hot water supply operation.
 HOT WATER	Lights while the electric cylinder heater is energized during hot water operation.
	Lights when heating is selected.
	Lights when cooling is selected.
	Lights during hot water supply is selected.
	Lights while internal pump (pump 1) or expansion pump (pump 2) is driven.
	Lights when the auxiliary boiler or external booster heater supports the heat pump operation.
 / 	Lights during water temperature control mode / room temperature control mode.
	Lights during Auto mode operation.
	Lights when Schedule timer or Floor drying is set to "ON".

	Lights when Night setback operation is set to "ON" and heating or cooling is selected.
	Lights while Silent mode operation is actually running.
	Lights while hot water boost is actually running.
	Lights when Anti bacteria operation is set to "ON" and hot water operation is selected.
	Lights while Frost protection operation is actually running.
	Lights when Test mode or Floor drying is set to "ON".
	Displays when the remote controller is set as Second remote controller.
	Lights when an error occurs and goes out when the error is cleared.
	Lights when an error occurs. This number is unit number.

■ Menu operation

- (1) Press the [] button, then the MENU screen is displayed.
- (2) Press the [] / [] button to select an item.
The selected item is highlighted.
- (3) Press the [] button. The setting screen appears.

To undo

Press the [] button to return. The display returns to the previous screen.

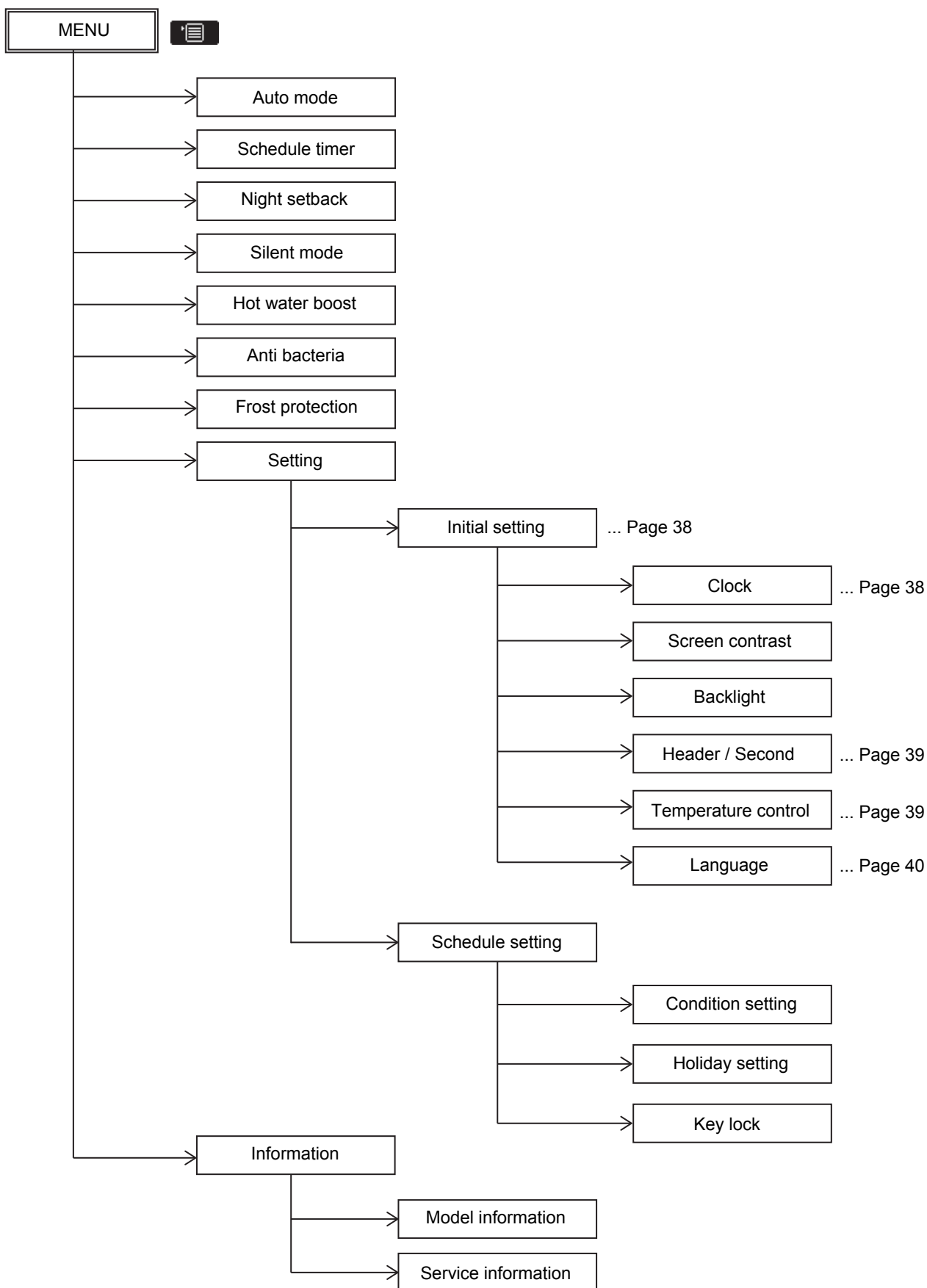

■ Menu items



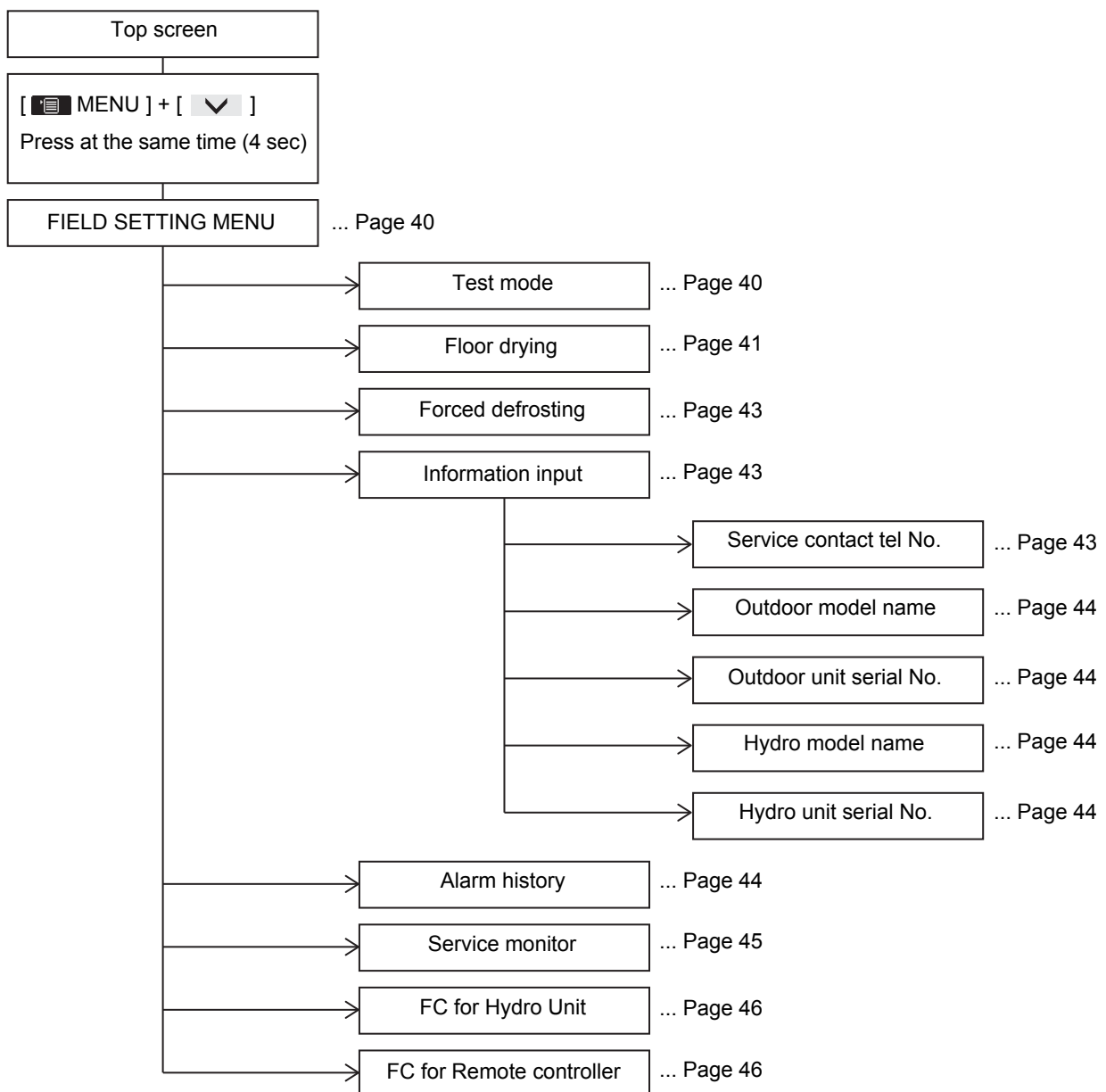



■ FIELD SETTING MENU items

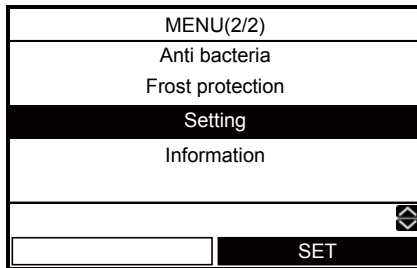

■ Setting – Initial setting –

- (1) Press the [] / [] button to select “Setting” on the MENU screen, then press the [] button.



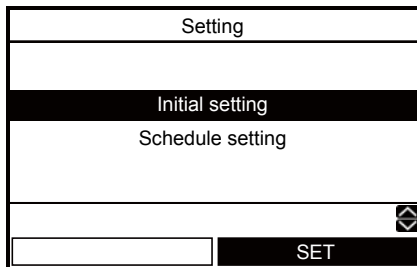

- (2) Press the [] / [] button to select “Initial setting” on the Setting screen, then press the [] button.





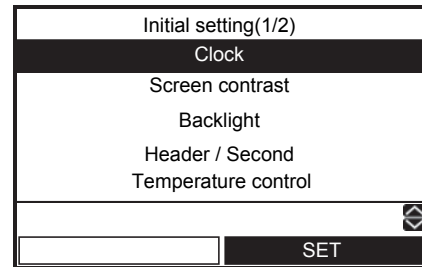

■ Clock

- Setting for the clock (date, month, year, time)

- (1) Press the [] / [] button to select “Clock” on the Initial setting screen, then press the [] button.



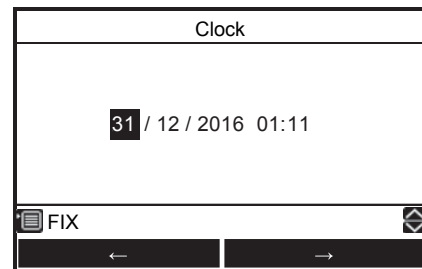

- (2) Press the [] / [] button to select the date, month, year, and, time.
- (3) Press the [] / [] button to set the value, then press the [] button.







- The clock display appears on the top screen.
- The clock display blinks if the clock setting has been reset due to power failure or other cause.

■ Header / Second

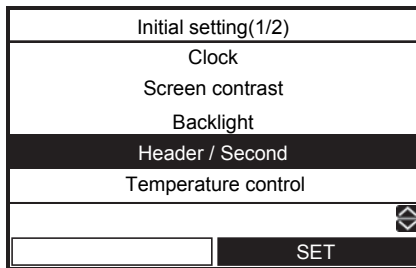
- For a dual remote controller system.
- Set one of remote controller as the header remote controller.
- Set another remote controller as the second remote controller.

(1) Press the [] / [] button to select “Header / Second” on the Initial setting screen, then press the [] button.



(2) Press the [] / [] button to select Header / Second, then press the [] button.

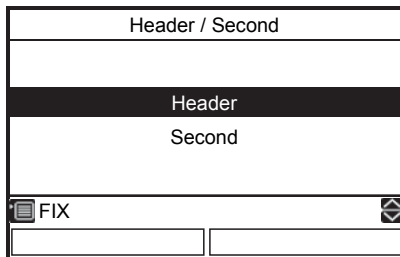



- Some function are not available when the remote controller is set as the “Second remote controller”.
- In the dual remote controller system, the latter operation overrides the former.
- The factory default is “Header remote controller”.

Disable function with second remote controller



- Schedule timer
- Silent mode
- Schedule setting

■ Temperature control

- To control room temperature instead of water temperature with this remote controller

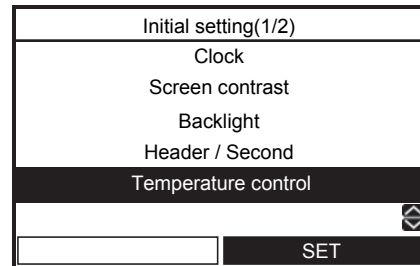
(1) Press the [] / [] button to select “Temperature control” on the Initial setting screen, then press the [] button.



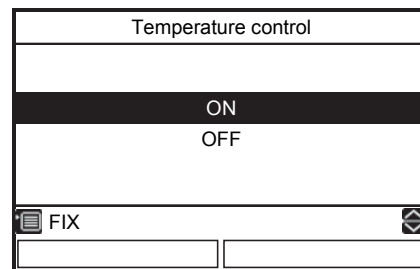

(2) Press the [] / [] button to select ON/OFF, then press the [] button.





- When the “Temperature control” is set to “ON”, the system is controlled with the sensor of the remote controller.
- The factory default is “OFF”.

■ Language

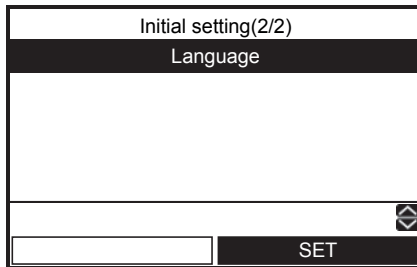
- Select a language for the screen text.
- (1) Press the [] / [] button to select “Language” on the Initial setting screen, then press the [] button.



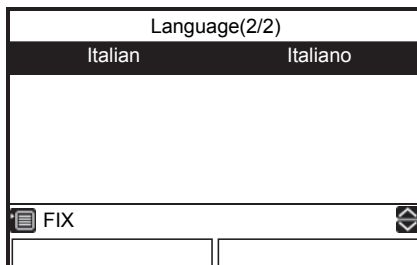
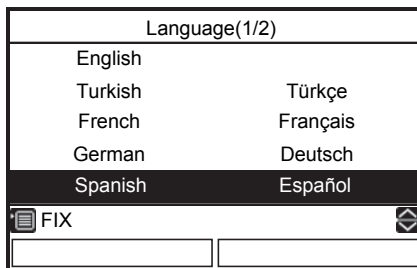

- (2) Press the [] / [] button to select the language, then press the [] button.



- The factory default is “English”.

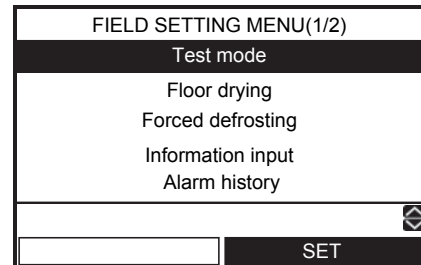

■ FIELD SETTING MENU

- (1) Press the [] button and the [] button at same time for 4 seconds or longer on the top screen to display the “FIELD SETTING MENU” to select “setting”





■ Test mode

- Even if the outside air temperature or water temperature is outside the setting value range, Heating, Cooling and Hot water supply operation become possible.
- Since the protection setting is disabled in the TEST mode, do not continue a test run longer than 10 minutes.

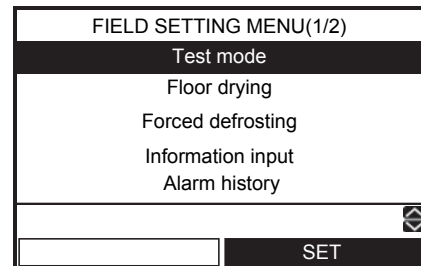
- (1) Press the [] / [] button to select “Test mode” on the FIELD SETTING MENU screen, then press the [] button.



- (2) Press the [] button to select ON, then press the [] button. The  mark appears on the top screen.

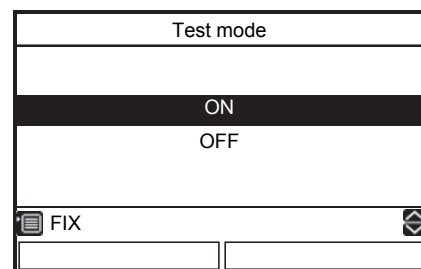

- (3) Start the heating or cooling or Hot water operation on the top screen, then the selected mode mark is blinking during Test mode.

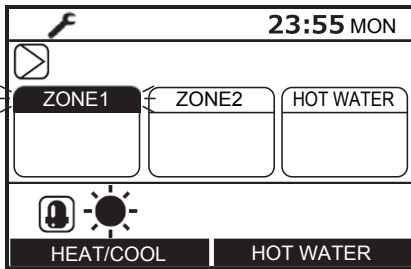

- The pump is activated in 30 seconds. If air is not released completely, the flow rate switch is activated to stop operation. Release air again according to the piping procedure. Little air entrainment is discharged from the purge valve.
- Check that the hydraulic pressure has become the predetermined pressure 0.1 to 0.2 MPa (1 to 2 bar). If the hydraulic pressure is insufficient, replenish water.
- Heating operation starts. Check that the hydro unit starts heating.
- Press the [F1] button to select the Cooling operation, in a few second, the operation starts.
- Check that the hydro unit starts cooling and that the floor heating system is not cooled.
- Press the [F1] button to stop the operation.
- Press the [F2] button to start the Hot water supply operation.
- Check that there is no air entrainment.
- Check that hot water is present at the connection port of the hot water cylinder.
- Press the [F2] button or [ON/OFF] button to stop the operation.

■ Floor drying

- This function is available only for the header remote controller.
- This function is used for drying concrete etc.
- Service personnel must operate the unit after setting the related function code.
- Operation is not started unless All the related function codes are set.
- Refer to the following for the settings of the related items. Please setup on the responsibility for an installer. An unsuitable setup may cause a crack of concrete etc.
- When the operation starts, the unit operates as follows.

- (1) Press the [▲] / [▼] button to select "Floor drying" on the FIELD SETTING MENU, then press the [F1] button for 4 seconds or longer.

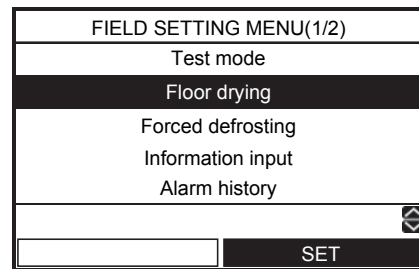

- FC:14 setting start and End temperature [20-55°C]
- FC:15 setting Max temperature [20-55°C]
- FC:16 continuation days for every step up to Max temperature [1-7 days]
- FC:17 temperature difference for every step up to Max temperature [1-10 K]
- FC:18 continuation days for every step down to End temperature [1-7 days]
- FC:19 temperature difference for every step down to End temperature [1-10 K]
- FC:1A Continuation days in Max temperature [1-30 days]

setting temperature

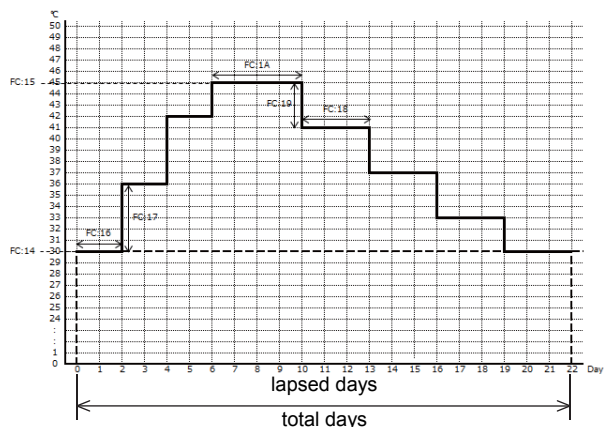

- (2) Press the [F1] / [F2] button to select FC number or Data, then press the [^] / [v] button to set the value.

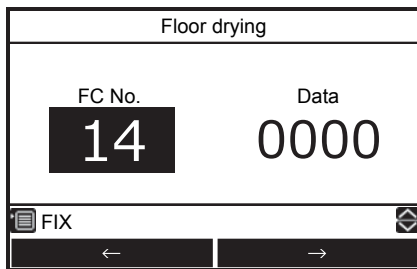

- (3) Press the [FIX] button. The set value is registered.

To start the operation

- (1) Press the [^] / [v] button to select “Floor drying” on the FIELD SETTING MENU, then press the [F2] button.

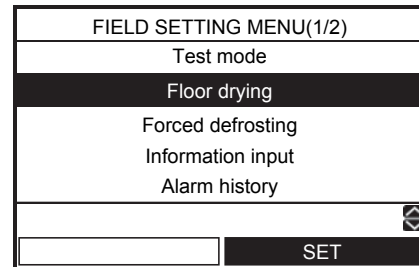

- (2) Press the [^] button to select the ON, then press the [FIX] button.

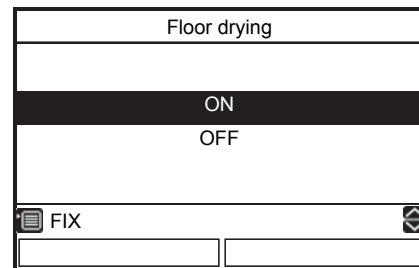

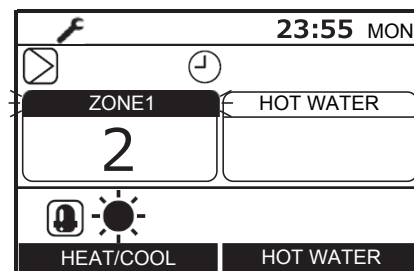

- Check the total days for Floor drying operation, then press [F1] button. The mark and mark appears on the Top screen.
- (3) Start the heating operation on the top screen.
- Then ZONE1 mark blinks during Floor drying operation and lapsed days are displayed.





- If some abnormalities occur during Floor drying operation, the System stops and Alarm history screen is displayed.
- After heating operation is stopped by operating the remote controller during Floor drying operation, if heating operation is again started within 30 minutes, Floor drying operation is started from the time of stopping.

■ Forced defrosting

- This function is available only for the header remote controller.
- This function can active the forced defrosting mode for the outdoor unit.

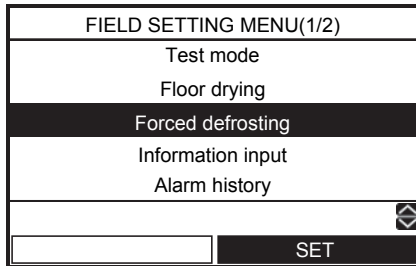
(1) Press the [] / [] button to select “Forced defrosting” on the FIELD SETTING screen, then press the [] button.



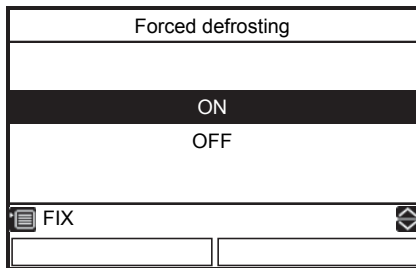

(2) Press the [] button to select ON, then press the [] button.



(3) Start the heating operation on the top screen.



■ Information input

- Register information about the contact number for Service, model name and serial number of the hydro unit and outdoor unit.

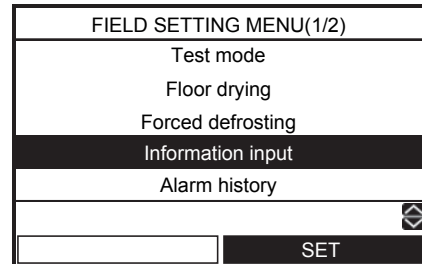
(1) Press the [] / [] button to select “Information input” on the FIELD SETTING MENU screen, then press the [] button.



Service contact tel No.

(1) Press the [] / [] button to select “Service contact tel No.” on the Information input screen, then press the [] button.

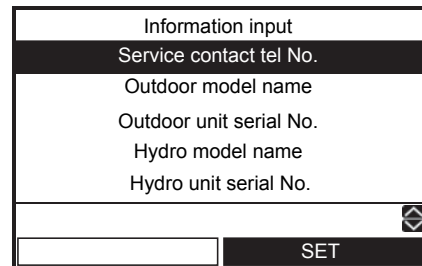

(2) Press the [] / [] button or [] / [] to select the value, then press the [] button.

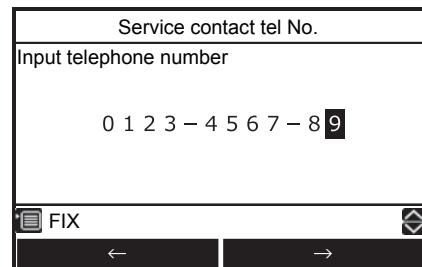

Outdoor (Hydro) model name
Outdoor (Hydro) unit serial No.

(1) Press the [] / [] button to select “Outdoor model name (Hydro model name, Outdoor unit serial No., Hydro unit serial No.)” on the Information input screen, then press the [] button.

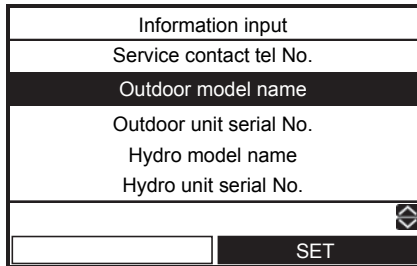

(2) Press the [] / [] button or [] / [] to select the character (the selected character is highlighted), then press the [] button. The character is displayed on the upper part of the screen from left-hand side.

If the [] button is pressed in the state where “Del” is selected, contents currently displayed is deleted from right-hand side.

Press the [] button in the state where “Fix” is selected to register contents currently displayed on the upper part of the screen.

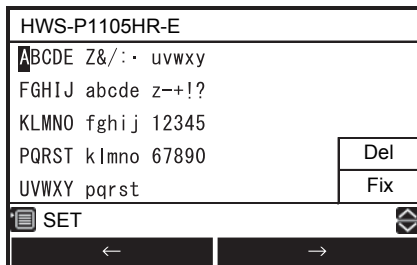

- After Information input has been finished, confirm the item “Information” on the MENU screen to check the information is registered correctly.

Alarm history

- List of latest 10 alarm data: error information of error code, date and time is displayed.

(1) Press the [] / [] button to select “Alarm history” on the FIELD SETTING MENU screen, then press the [] button.

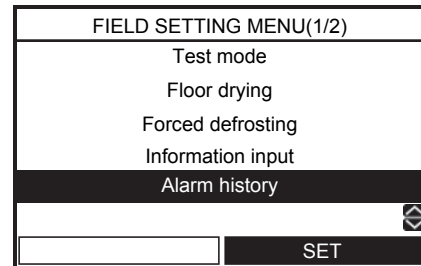

To reset the alarm history

(1) Press the [] button to reset the alarm history.

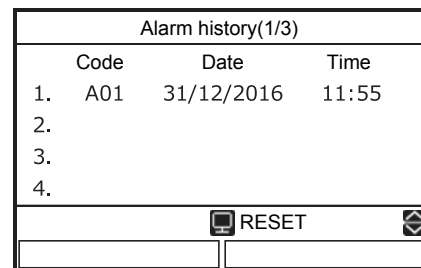

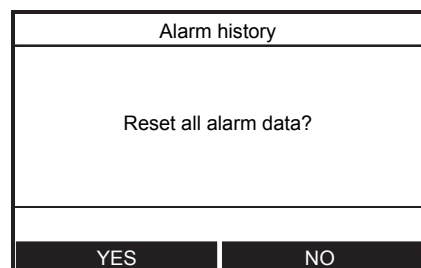

(2) Press the [] button, then all alarm data is cleared.





■ Service monitor

- The sensor sensing temperature is displayed on the remote controller.
- This function allows you to make sure whether the sensor is installed properly.

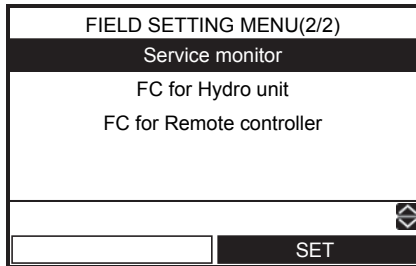
(1) Press the [] / [] button to select "Service monitor" on the FIELD SETTING MENU screen, then press the [] button.



(2) Press the [] button to select the unit, then press the [] button to display the status.

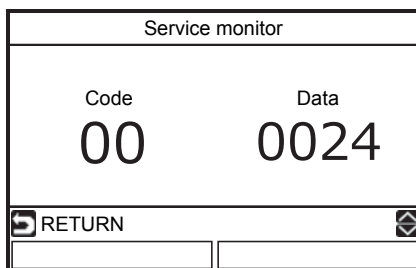
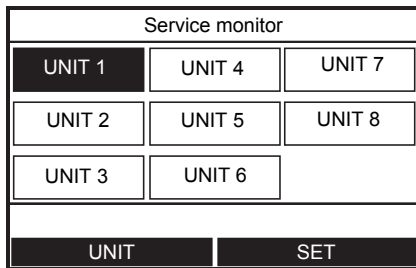

Hydro unit data	code	Data name	Unit
	00	Control temperature (Hot water cylinder)	°C
	01	Control temperature (Zone1)	°C
	02	Control temperature (Zone2)	°C
	03	Remote controller sensor temperature	°C
	04	Condensed temperature (TC)	°C
	06	Water inlet temperature (TWI)	°C
	07	Water outlet temperature (TWO)	°C
	08	Water heater outlet temperature (THO)	°C
	09	Floor inlet temperature (TFI)	°C
	0A	Hot water cylinder temperature (TTW)	°C
	0B	Mixing valve position	step
	0E	Low pressure (Ps) × 1/10	kPa
	0F	Hydro soft ver.	-



Outdoor unit data	code	Data name	Unit
	60	Heat exchange temperature (TE)	°C
	61	Outside air temperature (TO)	°C
	62	Discharge temperature (TD)	°C
	63	Suction temperature (TS)	°C
	65	Heat sink temperature (THS)	°C
	6A	Current × 10	A
	6D	Heat exchanger coil temperature (TL)	°C
	70	Compressor operation Hz	Hz
	72	Number of revolutions of outdoor fan (lower or 1 fan model)	rpm
	73	Number of revolutions of outdoor fan (upper)	rpm
	74	Outdoor PMV position × 1/10	pls
7A	Discharge pressure (PD) × 1/10	kPa	

Service unit data	code	Data name	Unit
	F0	Micro computer energized accumulation time × 1/100	h
	F1	Hot water compressor ON accumulation time × 1/100	h
	F2	Cooling compressor ON accumulation time × 1/100	h
	F3	Heating compressor ON accumulation time × 1/100	h
	F4	Built-in AC pump operation accumulation time × 1/100	h
	F5	Hot water cylinder heater operation accumulation time × 1/100	h
	F6	Backup heater operation accumulation time × 1/100	h
F7	Booster heater operation accumulation time × 1/100	h	

- Some sensors (temperature / pressure) are not displayed, because not connected.

■ FC for Hydro Unit (FC for Remote controller)



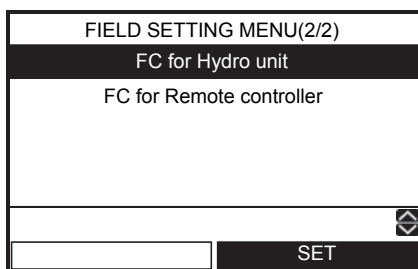

- Hydro unit function code setting is available only for the header remote controller.
- Set function codes for various operation modes with the remote controller.

(1) Press the [] / [] button to select “FC for Hydro unit” (or “FC for Remote controller”) on the FIELD SETTING screen, then press the [] button.

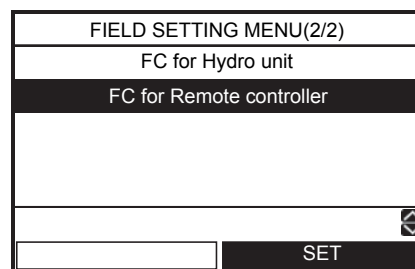

or



(2) Press the [] / [] button to select FC number or Data, then press the [] / [] button to set the value.

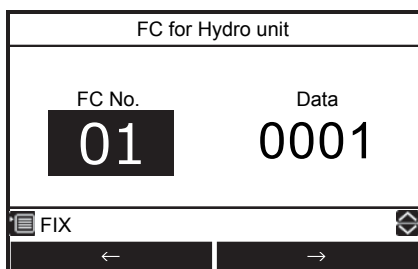

or

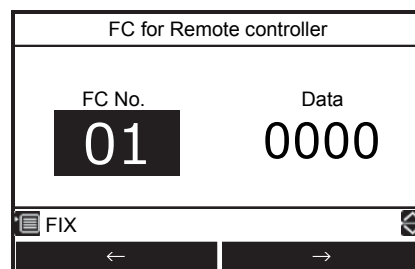

(3) Press the [] button. The set value is registered.

Main setting items

(1) Setting Temperature Range (function code 18 to 1F)

- Set the temperature range for heating (zone 1, zone 2), cooling, and hot water.
- The upper-limit and lower-limit temperatures of each mode can be set.

(2) Setting Heat Pump Operation Conditions for Hot Water Supply (function code 20 and 21)

- Set the heat pump start water temperature and heat pump stop water temperature.
- The heat pump starts working when the water temperature lowers below the set start water temperature. It is recommended that the default value be used.

(3) Compensating Hot Water Temperature (function code 24 and 25)

- Compensate the target temperature from the remote controller set temperature when the hot water temperature lowers below the set outside air temperature.

(4) Setting Hot Water Boost (function code 08 and 09)

- Set the control time and target temperature when the HOT WATER BOOST is operated.

(5) Setting Anti-Bacteria

- Set the control for the hot water cylinder when ANTI BACTERIA is operated.
- Set the target temperature, control period, start time (24-hour notation), and target temperature retention period.
- Make this control setting according to regulations and rules of respective countries.

(6) Setting Priority Mode Temperature

- Set the outside air temperature that changes the preferred operation mode.
- Hot Water - Heating Switching Temperature
Heating operation takes precedence when the temperature lowers the set temperature.
- Boiler HP Switching Temperature
When the temperature lowers the set temperature the external boiler output is made.

(7) Setting Heating Auto Mode Temperature (function code 27 to 31, A1 to A5)

- Compensate the target temperature when Auto is set for temperature setting on the remote controller.
- The outside air temperature (T0, T1 and T3) can be set individually.
- The target temperature can be set to a value from 20 to 60 °C.
- However, $A > B > C > D > E$.

▼ Fig. 9-02
<Zone 1>

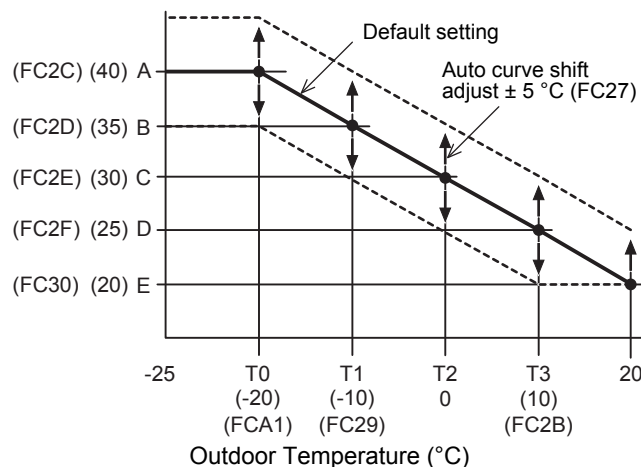

- The entire curve can be adjusted plus and minus 5 °C by function code 27.

<Zone 2>

You can choose either a percentage or a fixed value as the setting method of zone 2

FCA2 = "0" : percentage (FC31)

FCA2 = "1" : fixed value (FCA3), (FCA4), (FCA5)

However, zone 1 \geq zone 2

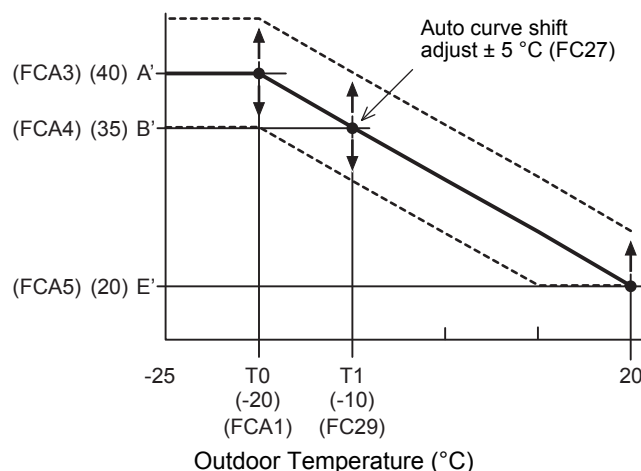

(8) Setting Frost Protection Temperature (function code 3A to 3B)

- Set the function when the Frost protection is set to "ON".
- Set enabling/disabling of this function and the target water temperature.
- If disabling is set, the frost protection operation is not performed even when the Frost protection is set to "ON".

(9) Setting Frequency of Output to Internal Heater (function code 33 to 34)

- The increase/decrease time is used to set the response time.

(10) Setting Night Setback (function code 26. remote controller function code 0E to 0F)

- Set the function when the Night setback is set to "ON".
- Set reduction temperature, start time, and end time.

(12) Hydro 2-Way Diverting valve operation. control

- When using both cooling and heating operations and there is an indoor unit only for heating (such as floor heating), install the 2-way valve and set this function code.

(13) Setting 3way Valve Operation (function code 54)

- This setting is not necessary for normal installation. Make this setting to invert the logic circuit in case ports A and B of the 3-way valve are wrongly attached and it cannot be rectified on site.

(14) Mixing valve operation setting

- Set the time period from full close to full open of the 2-zone control mixing valve. Set a value that is 1/10 of the actual time. And. setting the interval control time. (minutes)

(15) Setting Heating/Hot Water Switching when Boiler Is Used (function code 3E)

- When boiler is used, make this setting to operate the Hydro Unit by the instruction from the boiler.

(16) Setting Heat Pump Operating Time for Hot Water Supply Operation

- Set the time period from the start of heat pump run to the start of heater energization at the beginning of hot water supply operation. If a long period is set, it takes long time for heating water.

(17) Setting Cooling ON/OFF

- Set this function when performing cooling operation.

(18) Remote controller time indication

- 24-hour or 12-hour notation is selected for the timer.

(19) Setting Nighttime Quiet Operation

- Issue an instruction for low-noise mode operation to the outdoor unit. Enabling/disabling of this function, start time, and end time can be set.

(20) Setting Alarm Tone

- The remote controller alarm tone can be set.

(21) Second Remote controller and room temperature thermostat

- Set the initial temperature setting.

(22) Selection of mode of operation by external input

- Select the logic of an external input signal (option)

(23) Hydro Unit Capacity setting**(24) Second Remote controller target temperature setting****(25) Room temperature sensor setting****(26) Synchronization control at low outside temperature****(27) P1 pump speed control****(28) Restriction of backup heater energization during heating mode. (For energy saving)**

- When outdoor temperature is higher than the reference value, the backup heater is forcibly off during heating mode.
- Default : No restriction (Same as the conventional control)

(29) Interval operation of the pump during thermostat off operation (For energy saving)

- The pump of the hydro unit performs intermittent operation according to the outdoor temperature during thermostat off (compressor off) operation.
- Default : Continuous operation (Same as the conventional control)

(30) Backup heater energization control during defrosting (For energy saving)

- When the heater outlet temperature (THO) drops 2K below the $TSC_F - \beta$, the backup heater (3 kW) is energized. TSC_F is the assigned temperature with the remote controller.

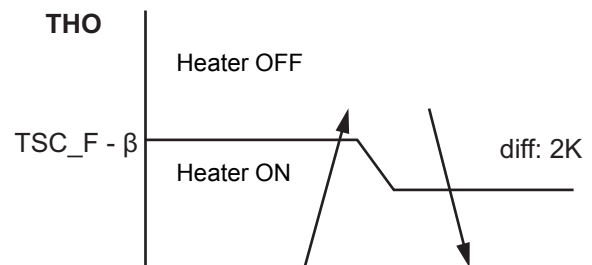

- Default : $\beta = 0$ (Same as the conventional control)

(31) Floor drying

- Please refer to the item of "FIELD SETTING MENU"

Function code settings

		Location & FC Number		Range	Default	After Commissioning	Change 1	Change 2
		FC Description	Hydro					
1	Setting Temperature Range	Heating Upper Limit - Zone 1	1A	-	37~60 °C	60		
		Heating Lower Limit - Zone 1	1B	-	20~37 °C	20		
		Heating Upper Limit - Zone 2	1C	-	37~60 °C	60		
		Heating Lower Limit - Zone 2	1D	-	20~37 °C	20		
		Cooling - Upper Limit	18	-	18~30 °C	25		
		Cooling - Lower Limit	19	-	7~20 °C	7		
		Hot Water - Upper limit	1E	-	60~75 °C	75		
		Hot Water - Lower limit	1F	-	40~60 °C	40		
2	Hot Water Operation	Heat Pump Start Temperature	20	-	20~45 °C	38		
		Heat Pump Stop Temperature	21	-	40~50 °C	45		
3	Hot Water Temperature Compensation	Temperature Compensation Outside Air Temperature (°C)	24	-	-20~10 °C	0		
		Compensation Temperature (°C)	25	-	0~15 °C	3		
4	Hot Water Boost	Operation Time (x10 min)	08	-	3~18	6		
		Setting Temperature (°C)	09	-	40~75 °C	75		
5	Anti Bacteria	Setting Temperature (°C)	0A	-	65~75 °C	75		
		Start Cycle (Day)	-	0D	1~10	7		
		Start Time (Hour)	-	0C	0~23	22		
		Operation Time (min)	0B	-	0~60	30		
6	Priority Mode	Hot Water & Heating Switching Temperature (°C)	22	-	-20~20	0		
		Boiler & Heat Pump Switching Temperature (°C)	23	-	-20~20	-10		
7	Heating Auto Curve Settings	Outside Temperature T0 (°C)	A1	-	-30~-20 °C	-20		
		Outside Temperature T1 (°C)	29	-	-15~0 °C	-10		
		Outside Temperature T2 (°C)	-	-	0	0		
		Outside Temperature T3 (°C)	2B	-	0~15 °C	10		
		Setting Temperature A at T0 (°C) - ZONE 1	2C	-	20~60 °C	40		
		Setting Temperature B at T1 (°C) - ZONE 1	2D	-	20~60 °C	35		
		Setting Temperature C at T2 (°C) - ZONE 1	2E	-	20~60 °C	30		
		Setting Temperature D at T3 (°C) - ZONE 1	2F	-	20~60 °C	25		
		Setting Temperature E at 20 °C (°C) - ZONE 1	30	-	20~60 °C	20		
		ZONE2 temperature setting 0 = Percentage (FC 31) 1 = Fixed value (FCA3~A5)	A2	-	0~1	0		
		Ratio Of Zone 2 In Zone 1 Auto Mode (%)	31	-	0~100%	80		
		Setting Temperature A' at T0 (°C) - ZONE 2	A3	-	20~60 °C	40		
		Setting Temperature B' at T1 (°C) - ZONE 2	A4	-	20~60 °C	35		
		Setting Temperature E' at 20 °C (°C) - ZONE 2	A5	-	20~60 °C	20		
Auto Curve - Temperature Shift (°C)	27	-	-5~5 °C	0				

		Location & FC Number							
		FC Description	Hydro	RC	Range	Default	After Commissioning	Change 1	Change 2
8	Frost Protection	Function 0 = Invalid; 1 = Valid	3A	–	0~1	1			
		Frost Protection Setting Temperature (°C)	3B	–	10~20 °C	15			
		End days	–	12	0~20	0			
		End times	–	13	0~23	0			
9	Back Up Heater Control	Downtime Back Up Heater 0 = 5min; 1 = 10min; 2 = 15min; 3 = 20min	33	–	0~3	1			
		Uptime Back Up Heater 0 = 10min; 1 = 20min; 2 = 30min; 3 = 40min	34	–	0~3	0			
10	Night Setback	Change Setback Temperature	26	–	3~20 °C	5			
		Zone selection 0 = Zone 1 & 2; 1 = Zone 1 Only	58	–	0~1	0			
		Start Time (Hour)	–	0E	0~23	22			
		End Time (Hour)	–	0F	0~23	06			
12	Hydro 2 Way Valve Operation Control	Cooling 2 Way Valve - Operation Logic 0 = Activated during cooling; 1 = Not activated during cooling	3C	–	0~1	0			
13	Hydro 3 Way Diverting Valve Operation Control	3 Way Diverting Valve Operation Logic 0 = Activated during hot water operation; 1 = not activated during hot water operation	54	–	0~1	0			
14	2 Zone Mixing Valve Drive Time	Specified Drive Time for Mixing Valve (x10sec)	0C	–	3~24	6			
		Mixing valve OFF (control time - mins)	59	–	1~30	4			
15	Boiler/Heat Pump Synchronisation	External Boiler/Heat Pump Synchronisation 0 = Synchronised; 1 = Not synchronised	3E	–	0~1	0			
16	Maximum Operation Time Of Hot Water Heat Pump	Maximum Heat Pump Operation Time In Hot Water Operation Priority Mode (minutes)	07	–	1~120	30			
17	Cooling Operation	0 = Cooling & Heating Operation; 1 = Heating Only Operation	02	–	0~1	0			
18	Remote controller Indication	24h or 12h Time Indication 0 = 24h; 1 = 12h	–	05	0~1	0			
19	CDU Night Time Low Noise Operation	Low Noise Operation 0 = Invalid; 1 = Valid	–	09	0~1	0			
		Start Time (Hour)	–	0A	0~23	22			
		End Time (Hour)	–	0B	0~23	06			
20	Alarm Tone	Tone Switching 0 = OFF; 1 = ON	–	11	0~1	1			
21	Second Remote controller and room temperature thermostat	Choice of the initial setting temperature 0 = The fixed temperature by FC9D 1 = The calculated temperature by Auto curve	B5	–	0~1	0			
		Fixed initial temperature setting	9D	–	20~60 °C	40			

		FC Description	Location & FC Number		Range	Default	After Commissioning	Change 1	Change 2
			Hydro	RC					
22	Operation by external input (option)	0 = Contacts low > high system stop. System restart with remote controller 1 = Contacts high > low system stop. System restart with remote controller 2 = Contacts high > low system stop. Contacts low > high system restart 3 = Contacts low > high system stop. Contacts low > high (second time) system restart	52	-	0~3	0			
		0 = Restart hot water and heating 1 = Restart in the mode when stopping 2 = Restart hot water 3 = Restart heating 4 = Tempo control 1; without heater 5 = Tempo control 2; without HP and heater	61	-	0~5	0			
		Changing the control of S1 (CN210) 0 = none 1 = Hot water supply control In addition, it is enabled only when switch 2_3 is set to "OFF" and FC61 is set to "3".	B6	-	0~1	0			
23	Hydro Unit Capacity Setting	0012 = P805XWH** 0015 = P1105XWH** Factory set but function code is needed for PCB replacement or function code reset procedure has been completed.	01	-	0012 or 0015	Depends on Hydro Unit			
24	Second Remote controller Target temperature Setting	0 = Water temperature 1 = Room thermo temperature	40	-	0~1	0			
25	Room Temperature Sensor Setting	Temperature shift for heating	-	02	-10~10	-1			
		Temperature shift for cooling	-	03	-10~10	-1			
26	Synchronization control at low outside temperature	0 = HP + Boiler 1 = Boiler 2 = Backup heater 3 = Boiler (Pump P1:stop)	5B	-	0~3	3			
27	P1 pump speed control (duty of the PWM)	0 = 100%, 1 = 90%, 2 = 80% 3 = 70%, 4 = 60%, 5 = 50%	A0	-	100%~50%	0			
28	Restriction of backup heater energization during heating mode	Forcibly heater off at $TO \geq A$ °C 0 = no restriction, 1 = 20 °C, 2 = 15 °C, ..., 6 = -5 °C	B8	-	0~6	0			
29	Interval operation of the pump 3 min ON/10 min OFF	Intermittent operation at $TO \geq A$ °C (heating mode) 0 = continuous operation 1 = 20 °C, ..., 6 = -5 °C	BA	-	0~6	0			
		intermittent operation at $TO < B$ °C (cooling mode) 0 = continuous operation 1 = 35 °C, ..., 3 = 25 °C	BB	-	0~3	0			

		FC Description	Location & FC Number		Range	Default	After Commissioning	Change 1	Change 2
			Hydro	RC					
30	Backup heater energization control during defrosting	β : 0 = 0K, ..., 4 = 40K Recommendation : $\beta=2$ (20K)	B9	–	0~4	0			
31	Floor drying	Setting Start and End temperature (°C)	–	14	20~55	0			
		Setting Max temperature (°C)	–	15	20~55	0			
		Continuation days for every step up to Max temperature (days)	–	16	1~7	0			
		Temperature difference for every step up to Max temperature (K)	–	17	1~10	0			
		Continuation days for every step down to End temperature (days)	–	18	1~7	0			
		Temperature difference for every step down to End temperature (K)	–	19	1~10	0			
		Continuation days in Max temperature (days)	–	1A	1~30	0			

■ Settings by purpose

Settings when hot water supply function is not used

- When the hot water supply function is not used, set DIP SW12-1 on the Hydro Unit board to ON. (Refer to page 31.)

Setting for cooling

- For Hydro Units that do not perform cooling (those for floor heating, etc.), procure a motorized 2-way valve (for cooling) (refer to “Control parts specifications” on page 21 for the details.) locally and attach it to the water pipe that is not used for cooling. Connect the valve cables to terminals TB05 (3) and (4) of the Hydro Unit.
- Stick the optional insulator for cooling to the bottom of the Hydro Unit.

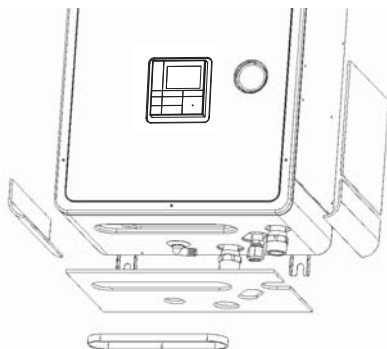

Settings for hot water supply

- Prepare the optional hot water cylinder.
- Procure a motorized 3-way valve (refer to “Control parts specifications” on page 21 for the details.) locally and perform piping. Connect the valve cables to terminals TB05 (7), (8) and (9) of the Hydro Unit.
- Set DIP SW12-1 on the Hydro Unit board to OFF. (Refer to page 31.)
- Connect the power supply unit for the hot water cylinder heater to terminals TB03 L and N of the Hydro Unit.
- Connect cables between the Hydro Unit and the hot water cylinder as follows: Hydro Unit terminals TB03 (1), (2), and earth — Hot water cylinder (1), (2), and earth
TB06 A, B, and earth — Hot water cylinder A, B, and earth

Settings for 2-zone temperature control

- Procure a motorized mixing valve (refer to “Control parts specifications” on page 21 for the details.) locally and perform piping. Connect the valve cables to terminals TB04 (1), (2), (3) and (4) of the Hydro Unit.
- Procure a buffer tank locally.
- Procure a water pump locally, and connect its cables to terminals TB05 (1) and (2) of the Hydro Unit.
To inhibit interlocking the water pump with the internal pump of the Hydro Unit, set DIP SW10-3 on the Hydro Unit board to OFF.
- Set DIP SW12-3 on the Hydro Unit board to ON.
(Refer to page 31.)
Attach the temperature sensor (TFI) connected to terminals TB06 C and D of the Hydro Unit near the hot water inlet of the Hydro Unit.
- Fix TFI sensor on the room heating supply pipe by using the connector procured in locally.
- Cover the cables with insulation tube (minimum 1 mm) or conduit so that the user cannot touch them directly.

- Cover the TFI sensor's cables and sensor with insulation tube (minimum 1 mm) shown in the diagram on the right.

▼ Fig. 9-03

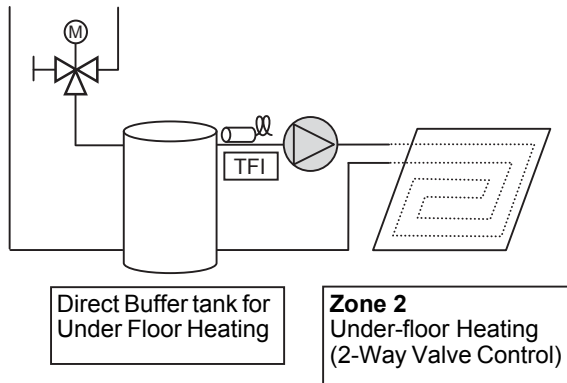

▼ Fig. 9-04

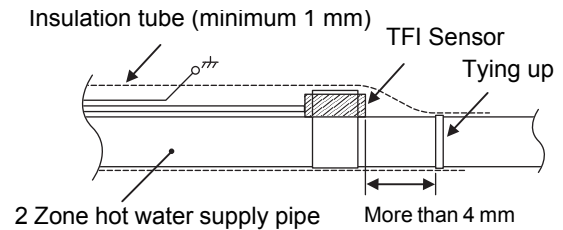

Setting for second remote controller

- Prepare the optional second remote controller.
- Connect the cable to terminals TB07 A,B of the Hydro unit and remote controller.

10 Maintenance

Execute periodic maintenance at least once a year.

Check points

- Check all electrical connections and make adjustments if they are necessary.
- Check the water pipes of the heating systems in particular any evidence of leakage.
- Check the expansion tank inner pressure. If it is insufficient, enclose nitrogen or dry air in the tank.
- Check that the hydraulic pressure is 0.1 MPa (1 bar) or more with a water manometer. If it is insufficient, replenish tap water.
- Clean the strainer.
- Check the pump for an abnormal sound or other abnormalities.

11 Troubleshooting

■ Fault symptoms

Symptom	Possible cause	Corrective action
Room is not heated or cooled. Water is not hot enough.	Incorrect remote controller setting	Check remote controller operation and temperature setting
	Incorrect function code setting	Check function code setting with the function code table.
	Backup heater disconnected	Check backup heater and bimetal thermostat.
	Insufficient capacity	Check selection of equipment.
	Sensor defect	Check whether temperature sensor is installed at the normal position.
Nothing is displayed on the remote controller.	Power is not supplied.	Check power supply wiring.
	Incorrect setting	Check DIP switch setting on the Hydro Unit board. Check the setting with the function code table.
Flow rate switch is activated. Error code [A01]	Air bite in the pump	Release air completely according to the procedure.
	Low hydraulic pressure	Set hydraulic pressure considering pipe height, and replenish water until manometer shows a value of set hydraulic pressure or more.
	Strainer is clogged.	Clean the strainer.
	Large resistance on the hydro side	Widen water path to the hydro unit or adopt a bypass valve.
	Malfunction of motorized 3-way valve for hot water supply	Check wiring and parts.
Hot water leaks from overpressure preventive valve.	Excessive hydraulic pressure	Set hydraulic pressure considering pipe height, and replenish water until manometer shows a value of set hydraulic pressure or more.
	Insufficient capacity of expansion tank	Check expansion tank capacity compared to total water amount. If it is insufficient, install another expansion tank.
	Expansion tank failure	Check the air pressure.

Defect mode detected by the Hydro Unit

Please don't continue backup operation in a state of displaying a check code.

Remove the cause of the anomaly immediately.

○ ... Possible

× Not possible

Check code	Diagnostic functional operation			Determination and action
	Operational cause	Backup operation	Automatic reset	
A01	Pump or flowing quantity error	Heating × Hot water ○	×	1. Almost no or little water flow. • Not enough vent air • Dirt clogging in the water piping system. • The water piping is too long. • Installation of buffer tank and secondary pump 1. Disconnection of the flow switch connector. 2. Defect of the flow switch.
	1) Detected by TC sensor			
	2) Detected by flow switch abnormality			
	3) Detection of chattering abnormality in the flow switch input			
	4) Disconnection of the flow switch connector			
A02	Temperature increase error (heating) (TWI, TWO, THO)	Heating × Hot water ○	○	1. Check the water inlet, water outlet and heater outlet (TWI, TWO, THO) sensors. 2. Defect of the backup heater (defect automatic reset thermostat).

○ ... Possible
 × ... Not possible

Check code	Diagnostic functional operation			Determination and action
	Operational cause	Backup operation	Automatic reset	
A03	Temperature increase error (hot water supply) (TTW)	Heating ○ Hot water ×	○	1. Check the hot water cylinder sensor (TTW). 2. Check the hot water cylinder thermal cut-out.
A04	Antifreeze operation	○	×	1. Almost no or little water flow. • Dirt clogging in the water piping system. • The water piping is too long or too short. 2. Check the heater power circuit. • Power supply voltage, breaker, power supply connection 3. Set the presence of the backup heater. 4. Check the water inlet, water outlet and heat exchange (TWI, TWO, TC) sensors and Flow Switch.
A05	Piping antifreeze operation	○	○	1. Check the heater power circuit. • Power supply voltage, breaker, power supply connection 2. Check the water inlet, water outlet and heater outlet sensors (TWI, TWO, THO). 3. Disconnection of the backup heater.
A07	Combination error Model name of the hydro unit is different.	×	×	1. Check DP_SW13_4 is set to "ON".
A08	Low pressure sensor operation error	○	×	1. Almost no or little water flow. 2. Defect of the flow switch. 3. On-load cooling or prolonged defrosting (a lot of frost formation) under the above conditions. 4. Defect in the low pressure sensor. 5. Check the refrigeration cycle (gas leak).
A09	Overheat protection operation (Thermostat of the backup heater)	Heating × Hot water ○	×	1. No water (heating without water) or no water flow. 2. Defect of the flow switch. 3. Defect of the backup heater (poor automatic reset thermostat).
A10	Antifreeze operation 2	○	×	1. Almost no or little water flow. 2. Check the water inlet, water outlet and heat exchange (TWO, TC) sensors.
A11	Operation of the release protection	Heating Cooling × Hot water ○	×	1. Almost no water flow. 2. Defect of the flow switch. 3. Check the water outlet temperature sensor (TWO).
A12	Heating, hot water heater error	○	○	1. Activated by a large load of heating or hot water supply. 2. Check the heater power circuit (backup or hot water cylinder heater). • Power supply voltage, breaker, power supply connection

O ... Possible
 × ... Not possible

Check code	Diagnostic functional operation			Determination and action
	Operational cause	Backup operation	Automatic reset	
A13	Pump error	Heating × Hot water O	×	1. Pump has stopped by a certain cause. <ul style="list-style-type: none"> • Low supply voltage. • High humidity around the electric box of the pump. • Dew condensation to the electric board of the pump. 2. Check the Flow switch in the Hydro unit. • Once turn off the power supply to the system and turn on again and operate the system.
E03	Regular communication error between hydro unit and remote controller	×	O	1. Check remote controller connection. 2. Defect in the remote controller.
E04	Regular communication error between hydro unit and outdoor unit	O	O	1. Check the serial circuit. • Miswiring of the crossover between the hydro unit and the outdoor unit
E08	Duplicate address of Hydro unit, or Duplicate master Hydro unit during Group control	×	O	1. Set the address No. of the Rotary switch "SW01" correctly for each Hydro unit.
E18	Regular communication error between master Hydro unit and slave Hydro unit during Group control	×	O	1. Check the Hydro unit connection. • Miswiring of the master and slave Hydro unit.
F03	TC sensor error	O	O	1. Check the resistance value and connection of the heat exchange temperature sensor (TC).
F10	TWI sensor error	O	O	1. Check the resistance value and connection of the water inlet temperature sensor (TWI).
F11	TWO sensor error	Heating × Hot water O	O	1. Check the resistance value and connection of the water outlet temperature sensor (TWO).
F14	TTW sensor error	Heating × Hot water O	O	1. Check the resistance value and connection of the hot water cylinder sensor (TTW).
F17	TFI sensor error	Heating × Hot water O	O	1. Check the resistance value and connection of the floor-inlet temperature sensor (TFI).
F18	THO sensor error	Heating × Hot water O	O	1. Check the resistance value and connection of the heater outlet temperature sensor (THO).
F19	Detection of THO disconnection error	Heating × Hot water O	×	1. Check for any disconnection of the heater outlet temperature sensor (THO).
F20	TFI sensor error	Heating × Hot water O	×	1. Check the connection of the floor-inlet temperature sensor (TFI).

○ ... Possible
 × ... Not possible

Check code	Diagnostic functional operation			Determination and action
	Operational cause	Backup operation	Automatic reset	
F23	Low pressure sensor error	○	○	1. Check the connection (body or connection wiring) of the low pressure sensor. 2. Check the resistance value of the low pressure sensor.
F29	EEROM error	×	×	1. Replace the P.C. board. (Hydro unit)
F30	Extended IC error	×	×	1. Replace the P.C. board. (Hydro unit)
L02	Combination error Model name of the outdoor unit is different.	×	×	1. Check the model name of the outdoor unit.
L03	Duplicate main Hydro unit during Group control	×	×	1. Set the address No. of the Rotary switch "SW01" correctly for each Hydro unit.
L07	Communication error	×	×	1. Replace the P.C. board. (Hydro unit)
L09	Communication error The capability code for the hydro unit has not been set.	×	×	1. Check the setting of the FC01 capability specifications. HWS-P805xx-E = 0012 HWS-P1105xx-E = 0015
L16	Setting error When ZONE1 has not been set, while ZONE2 has been set.	×	×	1. Check the body DP-SW12_2,3.
P31	Slave Hydro unit error which occurs when error occurs in master Hydro unit	×	○	1. Check the remote controller connection. 2. Defect in the remote controller. 3. Set the address No. of the Rotary switch "SW01" correctly for each Hydro unit.

Defect mode detected by the Outdoor Unit

Check code	Diagnostic functional operation			Determination and action
	Operational cause	Backup operation	Automatic reset	
F04	TD sensor error	○	×	1. Check the resistance value and connection of the discharge sensor (TD).
F06	TE sensor error	○	×	1. Check the resistance value and connection of the heat exchange temperature sensor (TE).
F07	TL sensor error	○	×	1. Check the resistance value and connection of the heat exchange temperature sensor (TL).
F08	TO sensor error	○	×	1. Check the resistance value and connection of the outdoor temperature sensor (TO).
F12	TS sensor error	○	×	1. Check the resistance value and connection of the suction temperature sensor (TS).
F13	TH sensor error	○	×	1. Check the resistance value and connection of the heat-sink temperature sensor (TH).
F15	TE, TS sensors error	○	×	1. Check for any wrong installation of the heat exchange temperature sensor (TE) and the suction temperature sensor (TS).
F24	PD sensor error	○	×	1. Check the value of PD sensor by the remote controller.
F31	EEPROM error	○	×	
H01	Compressor breakdown	○	×	1. Check the power supply voltage. 2. Over-loaded condition of the refrigeration cycle. 3. Check that the service valve is fully open.

Check code	Diagnostic functional operation			Determination and action
	Operational cause	Backup operation	Automatic reset	
H02	Compressor lock	O	×	1. Defect of compressor (lock) – Replace the compressor. 2. Defect of compressor wiring (open phase).
H03	Defect in the current detection circuit	O	×	1. Replace the outdoor inverter control board.
H04	Operation of case thermostat	O	×	1. Check the refrigeration cycle (gas leak). 2. Check the case thermostat and connector. 3. Check that the service valve is fully open. 4. Defect of the pulse motor valve. 5. Check for kinked piping.
L10	Unset service PC board jumper Jumpers have not been cut.	O	×	1. Cut outdoor PC board jumper wire (for service).
L15	Combination error Model name of the hydro unit is different.	×	×	1. Check the model name of the hydro unit. 2. Check DP_SW13_4 is set to "ON".
L29	The communication between the outdoor PC board MUCs error	O	×	1. Replace the outdoor control board.
P03	The outlet temperature error	O	×	1. Check the refrigeration cycle (gas leak). 2. Defect of the pulse motor valve. 3. Check the resistance value of the discharge temperature sensor (TD).
P04	The high pressure switch error	O	×	1. Almost no or little water flow. 2. Defect of the flow switch. 3. On-load operation under the above conditions. 4. Defect in the high pressure switch. 5. Failure of a refrigerant valve to open.
P05	The power supply voltage error	O	×	1. Check the power supply voltage.
P07	Overheating of heat-sink error	O	×	1. Check the thread fastening and heat-sink grease between the outdoor control board and the heat-sink. 2. Check the heat-sink fan duct. 3. Check the resistance value of the heat-sink temperature sensor (TH).
P15	Detection of gas leak	O	×	1. Check the refrigeration cycle (gas leak). 2. Check that the service valve is fully open. 3. Defect of the pulse motor valve. 4. Check for kinked piping. 5. Check the resistance value of the discharge temperature sensor (TD), the suction temperature sensor (TS). 6. Check the value of PD sensor by the remote controller.

Check code	Diagnostic functional operation			Determination and action
	Operational cause	Backup operation	Automatic reset	
P19	The 4-way valve inversion error	O	×	<ol style="list-style-type: none"> 1. Check the operation of the 4-way valve unit or the coil characteristics. 2. Defect of the pulse motor valve. 3. Check the resistance value of the heat exchange temperature sensor (TE) and the suction temperature sensor (TS).
P20	High pressure protection operation	O	×	<ol style="list-style-type: none"> 1. Check that the service valve is fully open. 2. Defect of the pulse motor valve. 3. Check the outdoor fan system (including clogging). 4. Over-filling of refrigerant. 5. Check the value of PD sensor by the remote controller. 6. The water piping is too short. Install a buffer tank or set the setting temperature lower.
P22	Outdoor fan system error	O	×	<ol style="list-style-type: none"> 1. Check the lock status of the motor fan. 2. Check the connection of the fan motor cable connector. 3. Check the power supply voltage.
P26	Short circuit of the compressor driver element error	O	×	<ol style="list-style-type: none"> 1. Abnormality occurs when operating with the compressor wiring disconnected ... Check the control board. 2. No abnormality occurs when operating with the compressor wiring disconnected ... Compressor rare short.
P29	Compressor rotor position error	O	×	<ol style="list-style-type: none"> 1. Even if the connection lead wire of the compressor is disconnected, it stops due to an abnormality in the position detection ... Replace the inverter control board. 2. Check the wire wound resistor of the compressor. Short circuit ... Replace the compressor.

Defect mode detected by the remote controller

Check code	Diagnostic functional operation			Determination and action
	Operational cause	Status of air-conditioning	Condition	
Not displaying at all (cannot operate by the remote controller)	No communication between hydro unit and remote controller	Stop	–	Defect in the remote controller power supply 1. Check the remote controller wiring. 2. Check the remote controller. 3. Check the hydro unit power supply wiring. 4. Check the water heat exchange control board.
E01	No communication between hydro unit and remote controller	Stop (Automatic reset)	Displayed when the abnormality is detected.	Defect in the reception of the remote controller 1. Check the remote controller crossover. 2. Check the remote controller. 3. Check the hydro power supply wiring. 4. Check the water heat exchanger board.
E02	Defect in the signal transmission to the hydro unit. (Detected on the remote controller side)	Stop (Automatic reset)	Displayed when the abnormality is detected.	Defect in the transmission of the remote controller 1. Check the transmitter circuit inside the remote controller. ... Replace the remote controller.
E09	Several remote controller base units (Detected on the remote controller side)	Stop (The handset continues)	Displayed when the abnormality is detected.	1.2 Check several base units with the remote controller ... The base unit is only one, and others are handsets.

