

MMK-UP_HP/HPL
UNIDAD DE PARED



Particularmente compacta, esta unidad de pared es perfecta para espacios limitados, por ejemplo en oficinas o pequeños comercios.

CAPACIDAD

NIVEL DE PRESIÓN SONORA



0,3 HP < 2,5 HP

25dB(A)

UNIDADES EXTERIORES COMPATIBLES



SMMS-e baja carga de refrigerante & MINI SMMS-e



SMMS-u



SMMS-e



SHRM-e

CONTROLES LOCALES



Incluido



RBC-ASCU11-E
RBC-AMTU31-E
RBC-AMSU51-EN/ES

CARACTERÍSTICAS

Nombre del modelo	Aplicación estándar	Aplicaciones de bajo ruido	MMK	UP0031HP-E	UP0051HP-E	UP0071HP-E	UP0091HP-E	UP0121HP-E	UP0151HP-E	UP0181HP-E	UP0241HP-E	UP0271HP-E	UP0301HP-E	UP0361HP-E								
			MMK	UP0031HPL-E	UP0051HPL-E	UP0071HPL-E	UP0091HPL-E	UP0121HPL-E	UP0151HPL-E	UP0181HPL-E	UP0241HPL-E											
Código de capacidad				0,3	0,6	0,8	1	1,25	1,7	2	2,5	3	3,2	4								
Capacidad de refrigeración			kW	0,9	1,7	2,2	2,8	3,6	4,5	5,6	7,1	8,0	9,0	10,0								
Capacidad de calefacción			kW	1,3	1,9	2,5	3,2	4,0	5,0	6,3	8,0	9,0	10,0	11,2								
Característ. eléctricas	Alimentación		Monofásica / 50Hz / 230V(220V-240V), Monofásica / 60 Hz / 220V (Se requiere una alimentación separada para las unidades interiores.)																			
	Corriente de funcionamiento	A	0,15	0,15	0,16	0,17	0,18	0,26	0,29	0,40	0,30	0,46	0,56	0,66								
	Consumo de energía	kW	0,013	0,013	0,015	0,016	0,017	0,028	0,032	0,05	0,034	0,054	0,066									
	Corriente de arranque	A	0,19	0,19	0,20	0,21	0,22	0,35	0,38	0,50	0,34	0,50	0,60									
Dimensiones (Alto x Ancho x P)	mm		293 x 798 x 230				320 x 1050 x 250				348 x 1200 x 280											
Peso	kg		11				16				21											
Caudal de aire (A / M / B)	m³/h		455/370/270		480/385/270		510/395/270		540/410/270		840/690/550		900/720/550		1200/900/600		1200/1000/800		1500/1300/1100		1650/1350/1250	
Nivel de presión sonora (A / M / B)	dB(A)		33/29/25		35/30/25		36/31/25		37/32/25		40/36/32		41/37/32		45/39/33		43/41/39		48/44/41		50/45/43	
Nivel de potencia sonora (Alto)	dB(A)		48		50		51		52		55		56		60		60		63		65	
Intercambiador de calor			Tubo aleado																			
Material de aislamiento térmico/acústico			Aislamiento no inflamable																			
Ventilador			Ventilador tangencial																			
Control (suministrado con la unidad)			WH-TA09NE																			
Tubería de conexión	Lado gas	pulgadas	1/2"	1/2"	1/2"	1/2"	1/2"	1/2"	1/2"	1/2"	5/8"	5/8"	5/8"	5/8"								
	Lado líquido	pulgadas	1/4"	1/4"	1/4"	1/4"	1/4"	1/4"	1/4"	1/4"	3/8"	3/8"	3/8"	3/8"								
Diámetro puerto de drenaje	mm		16 (Tubo de cloruro de polivinilo)																			

ESQUEMÁTICOS

Unidad: mm

MMK-UP0031HP(L)-E a MMK-UP0121HP(L)-E

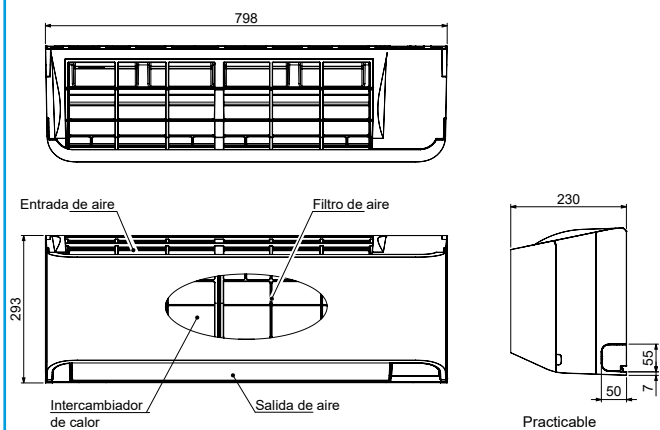

MMK-UP0151HP(L)-E a MMK-UP0241HP(L)-E

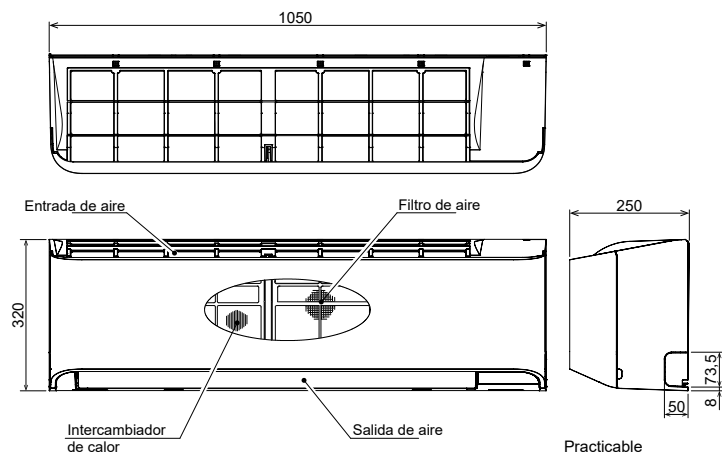

NIVELES DE PRESIÓN SONORA

Unidad: dB(A)

MMK-UP0031HP(L)-E, UP0051HP(L)-E

Nivel de presión sonora (dB(A))	HH-H-L
	35-31-28

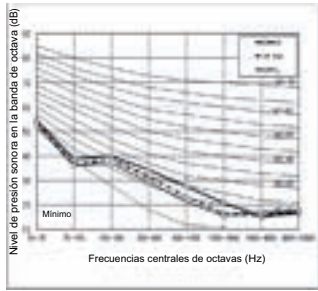

MMK-UP0071HP(L)-E

Nivel de presión sonora (dB(A))	HH-H-L
	37-32-28

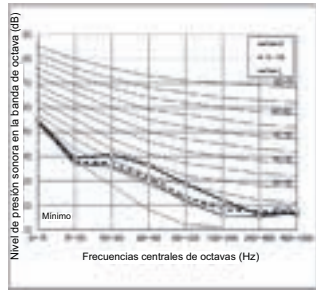

MMK-UP0091HP(L)-E

Nivel de presión sonora (dB(A))	HH-H-L
	41-36-33

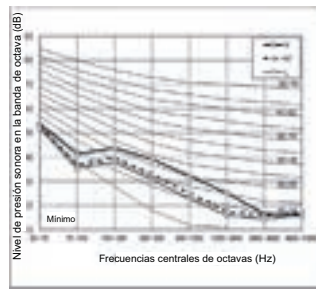

MMK-UP0121HP(L)-E

Nivel de presión sonora (dB(A))	HH-H-L
	46-39-34

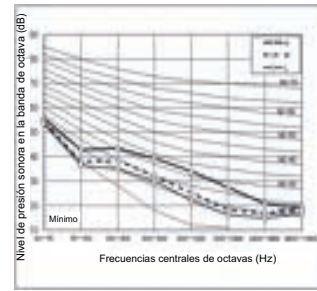

MMK-UP0151HP(L)-E

Refrigeración

Velocidad ventilador	H	M	L
Nivel de presión sonora (dB(A))	40	36	32

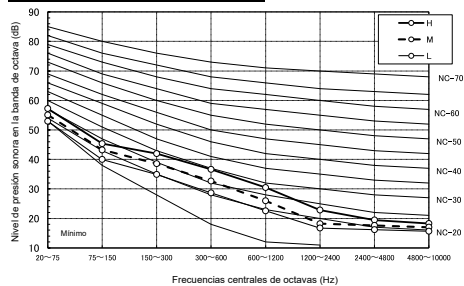

MMK-UP0181HP(L)-E

Refrigeración

Velocidad ventilador	H	M	L
Nivel de presión sonora (dB(A))	41	37	32

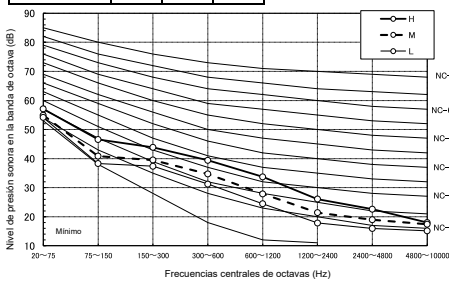

MMK-UP0241HP(L)-E

Refrigeración

Velocidad ventilador	H	M	L
Nivel de presión sonora (dB(A))	45	39	33

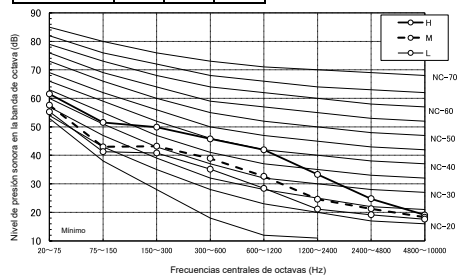

DIFUSIÓN DE AIRE

Unidad: m/s

MMK-UP0031HP(L)-E

Veloc. alta : 3,8m/s
Veloc. media : 2,8m/s
Veloc. baja : 2,5m/s

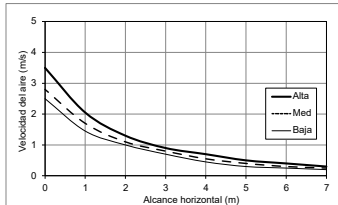

MMK-UP0071HP(L)-E

Veloc. alta : 3,9m/s
Veloc. media : 3,0m/s
Veloc. baja : 2,5m/s

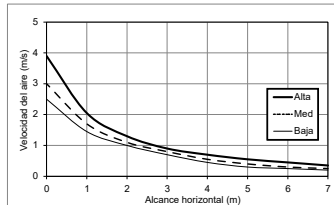

MMK-UP0091HP(L)-E

Veloc. alta : 4,1m/s
Veloc. media : 3,2m/s
Veloc. baja : 2,5m/s

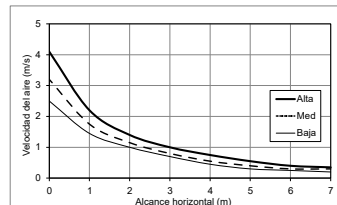

MMK-UP0121HP(L)-E

Veloc. alta : 4,3 m/s
Veloc. media : 3,4 m/s
Veloc. baja : 2,5 m/s

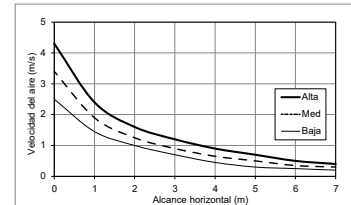

MMK-UP0151HP(L)-E

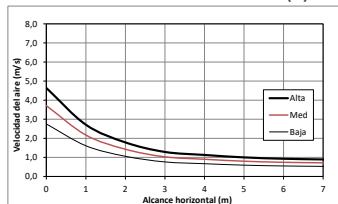

MMK-UP0181HP(L)-E

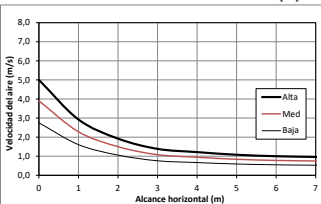

MMK-UP0241HP(L)-E

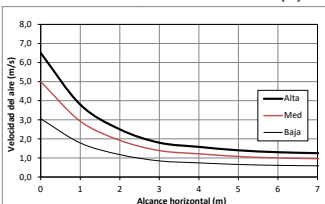

Veloc. alta : 4,6 m/s
Veloc. media : 3,7 m/s
Veloc. baja : 2,8 m/s

Veloc. alta : 5,0 m/s
Veloc. media : 3,9 m/s
Veloc. baja : 2,8 m/s

Veloc. alta : 6,5 m/s
Veloc. media : 5,0 m/s
Veloc. baja : 3,1 m/s

ACCESORIOS

Tipo	Nombre del modelo	Modelo aplicado	Apariencia	Observaciones
Kit PMV	RBM-PMV0301U-E	Unidad de pared de 0,3 a 1.25HP		Necesario para unidades de pared para aplicaciones de bajo ruido.
	RBM-PMV0901U-E	Unidad de pared de 1.7 a 3,0HP		

CONECTORES INTEGRADOS DE LA UNIDAD DE PARED

CN32	CN60	CN61	CN70	CN73	CN80
Control de ventilación adicional del control remoto.	Salida de señal de estado de funcionamiento (refrigeración, calefacción, ventilador, desescarche, termostato on).	On/Off externo, salida de funcionamiento y salida de alarma.	Símbolo de advertencia en el control remoto basado en la señal de entrada. Ninguna unidad interior con termostato desactivado.	Desconexión forzada del termostato de la unidad interior en función de la señal de entrada.	Desconexión forzada del termostato de la unidad interior y bloqueo de la unidad interior en función de la señal de entrada.